



PRODUCTS GUIDE



MEGADYNE

ABOUT US



Founded in 1957 and based in Mathi (Italy), Megadyne is a global manufacturer of rubber and urethane drive belts and associated components used in power transmission, product handling and linear positioning applications.

Megadyne has grown from being a small family company to an international leader in its related fields. It has many manufacturing plants (located in Europe, Asia and America) and more than 50 commercial locations where industry leading manufacturing, excellent customer service and advanced distribution and fabrication capabilities are provided. Megadyne produces a wide range of thermoplastic polyurethane open-end and truly-endless timing belts as well as rubber timing belts, v-belts, flat belts and related metal drive components. Megadyne delivers solutions to industry not only with innovative standard products, but also with custom constructions and fabrication capabilities such as the application of cleats, tracking guides, co-extruded and fabricated covers, machined modifications and other made-to-order solutions capable of durably handling extreme environmental conditions.

Megadyne partners with Original Equipment Manufacturers and Distributors worldwide to engineer solutions for the most demanding applications in areas as diverse as elevators, machine tools, food industry equipment, packaging, and ceramics ... just to name a few of the many industrial markets where you'll find the Megadyne name.

Megadyne's philosophy of "Fast, Flat, Friendly & Flexible" has earned our reputation as the kind of company that people want to do business with. After six decades of progressive expansion, organic development and strategic acquisitions, Megadyne remains committed to investing in best-in-class manufacturing, distribution and fabrication capabilities.



MEGADYNE WORLDWIDE PRESENCE

EMEA PRODUCTION CENTERS



HEADQUARTERS - MATHI - TORINO - ITALY



BYDGOSZCZ - POLAND



VILANOVA - BARCELONA - SPAIN

EMEA DISTRIBUTION CENTERS

- Turin - ITALY
- Pescara - ITALY
- Venice - ITALY
- Prague - CZECH REPUBLIC
- Bondoufle - FRANCE
- Borchen - GERMANY
- Budapest - HUNGARY
- Dublin - IRELAND
- Bielsko Biala - POLAND
- Barcelona - SPAIN
- Kristianstad - SWEDEN
- Izmir - TURKEY
- Birmingham - UK
- Wolverhampton - UK
- Johannesburg - SOUTH AFRICA
- Cape Town - SOUTH AFRICA

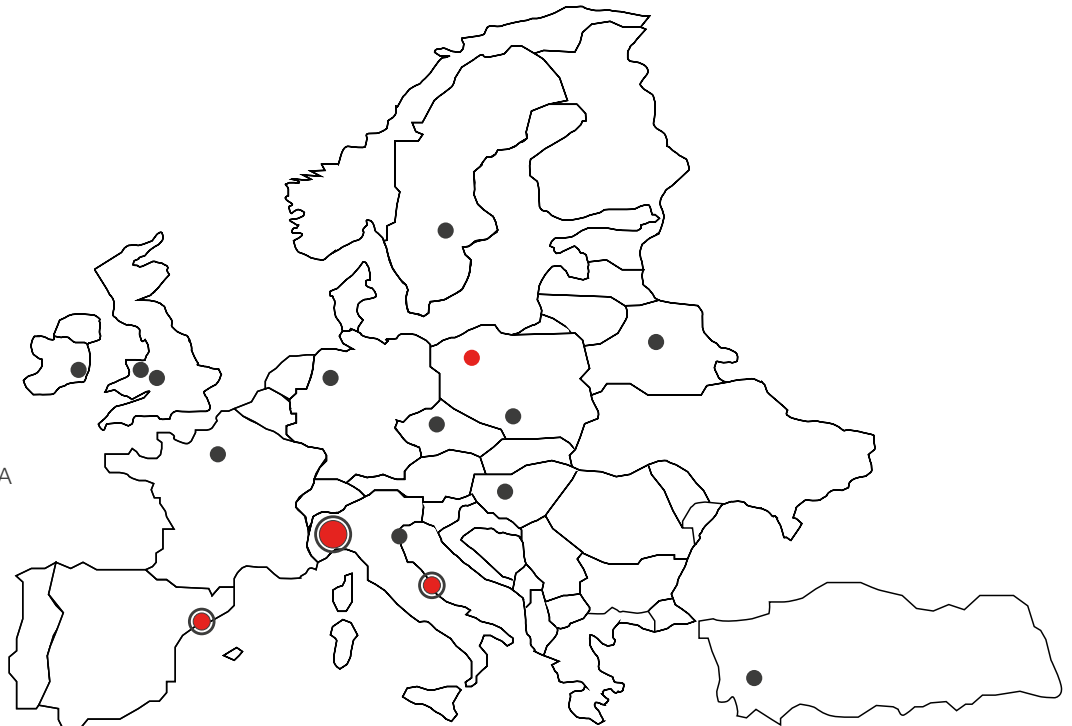

- DISTRIBUTION AND PRODUCTION
- PRODUCTION CENTERS
- DISTRIBUTION CENTERS

MEGADYNE WORLDWIDE PRESENCE

AMERICAS PRODUCTION CENTERS



ATLANTA - GA - U.S.A.



CHARLOTTE - NC - U.S.A.

AMERICAS DISTRIBUTION CENTERS

- Fairfield - NJ - USA
- Carol Stream - IL - USA
- Dallas - TX - USA
- Los Angeles - CA - USA
- Portland - OR - USA
- Tampa - FL - USA
- Toronto - Ontario - CANADA
- Montreal - Quebec - CANADA
- Alberta - Edmonton - CANADA
- Azcapotzalco - MEXICO
- Sao Paulo - BRAZIL
- Bogotá - COLOMBIA
- Cartagena - COLOMBIA
- Lima - PERU

ASIA & PACIFIC PRODUCTION CENTERS



QINGDAO - CHINA



NINGBO - CHINA



CHENNAI - INDIA



ASIA & PACIFIC DISTRIBUTION CENTERS

- Chennai - Tamil Nadu - INDIA
- Nagoya - JAPAN
- Foshan - P.R.C.
- Ningbo - P.R.C.
- Shanghai - P.R.C.
- Qingdao - P.R.C.
- Bangkok - THAILAND
- Melbourne - AUSTRALIA

- DISTRIBUTION AND PRODUCTION
- PRODUCTION CENTERS
- DISTRIBUTION CENTERS

INDEX

TIMING BELTS	5
Isoran rubber endless	6
Isoran rubber open end	11
Megapower	13
Megaflex	17
Megalinear	21
FLAT BELTS	25
Megaflat - PU and Rubber endless flat belts	26
V-BELTS	27
Wrapped (Extra, Oleostatic, Olesostatic Gold)	28
Wrapped double side (Esaflex)	34
Wrapped bare back (XDV2)	35
Banded (Pluriband)	36
Raw edge (Linea Gold, Linea X, Varisect)	37
Accu-link	42
MULTI RIB BELTS	43
Pv - Rubber ribbed belt	44
Megarib - PU endless ribbed belts	45
SPECIAL & FABRICATED BELTS	46
Megaweld	47
Covers	48
Cleats	50
False Teeth	51
PPJ System	51
Special modifications	52
POWER TRANSMISSION COMPONENTS	53

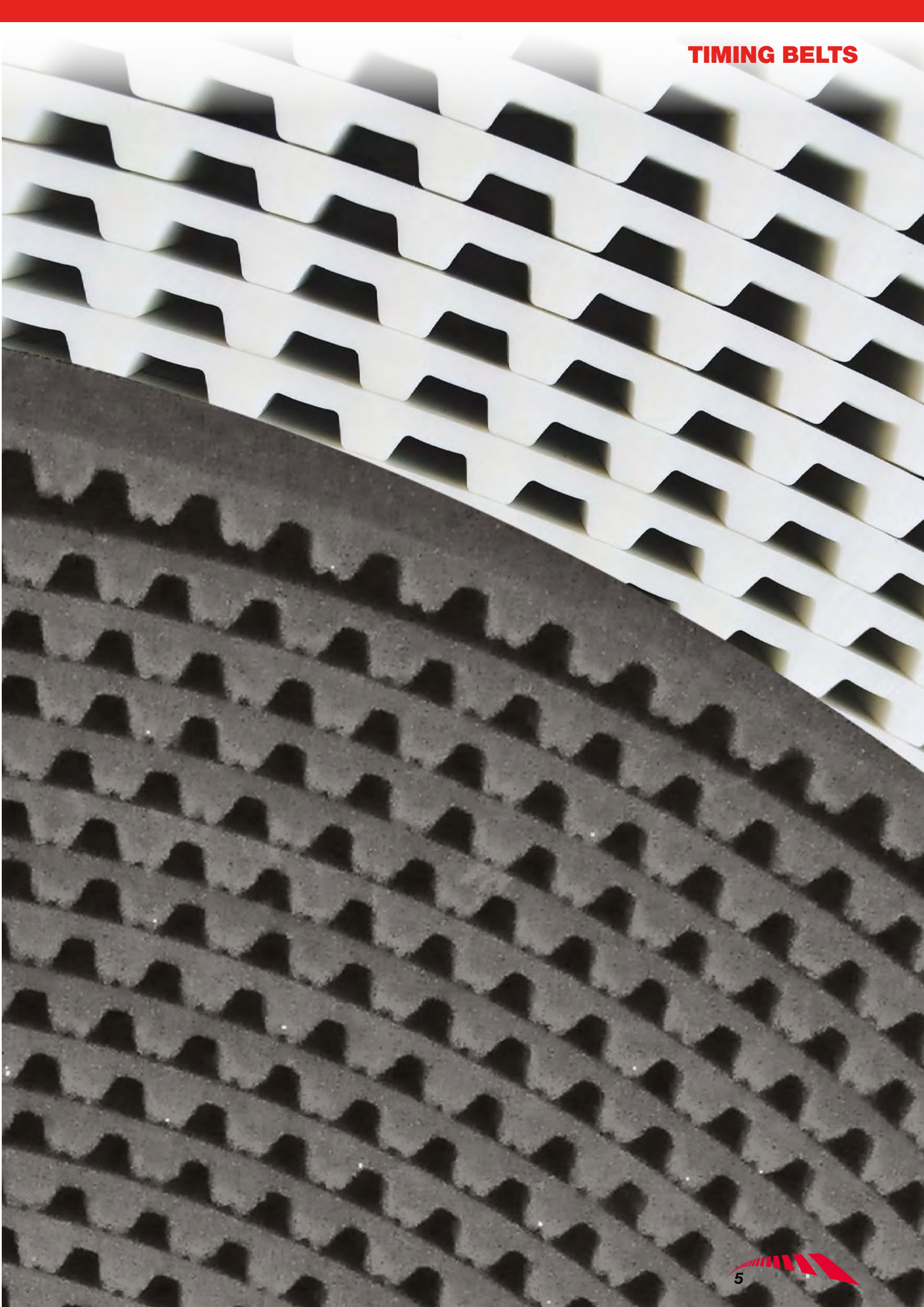

ISORAN

Rubber endless timing belts

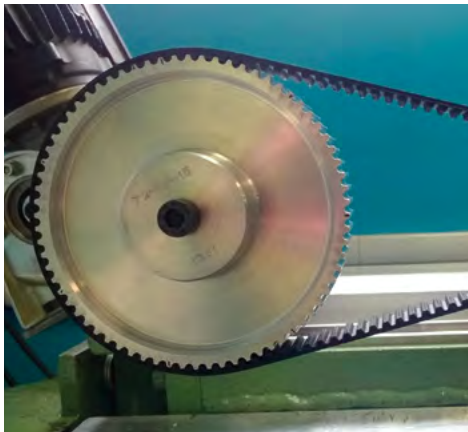

MEGADYNE RUBBER timing belts are available with single or double sided teeth, in imperial and RPP profiles. They are manufactured using the most advanced technology available.

ISORAN IMPERIAL SYNCHRONOUS MXL XL L H XH XXH

- Trapezoidal tooth profile
- Polychloroprene teeth for accurate meshing
- Fiberglass reinforcement for minimal elongation
- Nylon fabric protecting tooth surface

ISORAN STD, HTB

- Curvilinear tooth profile
- Same properties of RPP belts

ISORAN RPP3 RPP5 RPP8 RPP14

- RPP parabolic tooth profile gives graduated pressure increase over tooth height
- Chloroprene rubber for wear resistance and increased service life
- Fiberglass reinforcement for minimal elongation and high flexibility
- Nylon fabric protecting tooth surface, with self lubrication

RPP SILVER, RPP SILVER2 and **RPP GOLD** are constructed with the highest quality materials. That guarantee following advantages:

- Upgrade the existing transmission without changing the pulleys
- Perfect interchangeability with parabolic and deep pulley profile
- Antistatic Properties conforming to the ISO 9563 (for Silver 5M only on request)
- Drive energy efficiency up to 98%
- Excellent for backside idlers
- Higher tooth jump resistance and increased resistance to tooth shear
- Quiet, maintenance-free operation

ISORAN PLATINUM is a rubber based timing belt, which solves the problems related to steel and aramide cords, thanks to the development and usage of its innovative "Dual Core" hybrid cord technology. PLATINUM reaches the highest level of performances incorporating this cord in a new rubber matrix and covering the teeth with a special and unique heavy fabric.

Thanks to the innovative materials used, PLATINUM:

- Increased basic power capacity by up to 40% compared to the current RPP GOLD;
- Use of existing RPP pulleys, maintaining a full functional interchange with other deep pulley profile systems, like HTD profile, etc.
- Allows existing drives to be upgraded without the necessity to replace the pulleys, just the belt itself.
- Reduction of noise by reduced belt widths due to the higher performance rating of the system. Under the same transmission conditions, PLATINUM has the same noise level of RPP GOLD;
- Low noise characteristics compared to drive systems using polyurethane, steel etc. due to the rubber matrix and its teeth with the parabolic profile shape, recognized as the quietest system on the market
- A wide, continuous range of possible operating temperature, like no other system, which makes PLATINUM the only solution for extreme working conditions.



ISORAN

Rubber endless timing belts

ISORAN STD

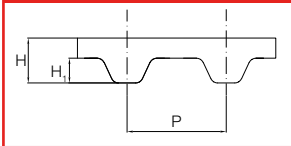

ISORAN HTB

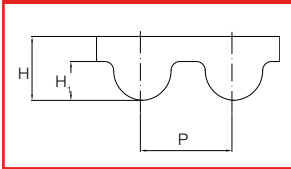

STD8

Code	Pitch length (mm)
656 STD8	656
800 STD8	800
840 STD8	840
848 STD8	848
880 STD8	880
896 STD8	896
936 STD8	936
1000 STD8	1000
1056 STD8	1056
1096 STD8	1096
1104 STD8	1104
1120 STD8	1120
1152 STD8	1152
1160 STD8	1160
1168 STD8	1168
1184 STD8	1184
1200 STD8	1200
1216 STD8	1216
1248 STD8	1248
1256 STD8	1256
1304 STD8	1304
1320 STD8	1320
1328 STD8	1328
1344 STD8	1344
1352 STD8	1352
1360 STD8	1360
1384 STD8	1384
1400 STD8	1400
1408 STD8	1408
1440 STD8	1440
1552 STD8	1552
1728 STD8	1728
1800 STD8	1800
1912 STD8	1912
2304 STD8	2304
P 8	
H₁ 3,05	
H 5,4	

HTB 3M

Code	Pitch length (mm)
171 HTB 3M	171
174 HTB 3M	174
177 HTB 3M	177
216 HTB 3M	216
225 HTB 3M	225
246 HTB 3M	246
255 HTB 3M	255
264 HTB 3M	264
276 HTB 3M	276
285 HTB 3M	285
300 HTB 3M	300
306 HTB 3M	306
312 HTB 3M	312
318 HTB 3M	318
336 HTB 3M	336
375 HTB 3M	375
420 HTB 3M	420
447 HTB 3M	447
483 HTB 3M	483
501 HTB 3M	501
537 HTB 3M	537
558 HTB 3M	558
564 HTB 3M	564
585 HTB 3M	585
633 HTB 3M	633
1002 HTB 3M	1002
P 3	
H₁ 1,13	
H 2,2	

HTB 5M

Code	Pitch length (mm)
215 HTB 5M	215
240 HTB 5M	240
270 HTB 5M	270
320 HTB 5M	320
340 HTB 5M	340
350 HTB 5M	350
355 HTB 5M	355
375 HTB 5M	375
385 HTB 5M	385
400 HTB 5M	400
420 HTB 5M	420
450 HTB 5M	450
475 HTB 5M	475
500 HTB 5M	500
520 HTB 5M	520
525 HTB 5M	525
535 HTB 5M	535
540 HTB 5M	540
550 HTB 5M	550
560 HTB 5M	560
575 HTB 5M	575
615 HTB 5M	615
630 HTB 5M	630
635 HTB 5M	635
645 HTB 5M	645
655 HTB 5M	655
670 HTB 5M	670
710 HTB 5M	710
740 HTB 5M	740
750 HTB 5M	750
770 HTB 5M	770
800 HTB 5M	800
825 HTB 5M	825
835 HTB 5M	835
850 HTB 5M	850
890 HTB 5M	890
900 HTB 5M	900
925 HTB 5M	925
950 HTB 5M	950
965 HTB 5M	965
980 HTB 5M	980
1000 HTB 5M	1000
1050 HTB 5M	1050
1145 HTB 5M	1145
1160 HTB 5M	1160
1225 HTB 5M	1225
1250 HTB 5M	1250
1270 HTB 5M	1270
1350 HTB 5M	1350
1400 HTB 5M	1400
1420 HTB 5M	1420
1500 HTB 5M	1500
1595 HTB 5M	1595
2000 HTB 5M	2000
2100 HTB 5M	2100
P 5	
H₁ 2,1	
H 3,6	

HTB 8M

Code	Pitch length (mm)
288 HTB 8M	288
480 HTB 8M	480
536 HTB 8M	536
560 HTB 8M	560
600 HTB 8M	600
616 HTB 8M	616
632 HTB 8M	632
640 HTB 8M	640
656 HTB 8M	656
720 HTB 8M	720
760 HTB 8M	760
800 HTB 8M	800
840 HTB 8M	840
856 HTB 8M	856
880 HTB 8M	880
912 HTB 8M	912
920 HTB 8M	920
960 HTB 8M	960
1000 HTB 8M	1000
1040 HTB 8M	1040
1080 HTB 8M	1080
1120 HTB 8M	1120
1152 HTB 8M	1152
1200 HTB 8M	1200
1224 HTB 8M	1224
1256 HTB 8M	1256
1280 HTB 8M	1280
1304 HTB 8M	1304
1360 HTB 8M	1360
1400 HTB 8M	1400
1440 HTB 8M	1440
1552 HTB 8M	1552
1600 HTB 8M	1600
1760 HTB 8M	1760
1800 HTB 8M	1800
2000 HTB 8M	2000
2032 HTB 8M	2032
2104 HTB 8M	2104
2240 HTB 8M	2240
2400 HTB 8M	2400
2600 HTB 8M	2600
2800 HTB 8M	2800
4400 HTB 8M	4400
P 8	
H₁ 3,4	
H 5,6	

HTB 14M

Code	Pitch length (mm)
966 HTB 14M	966
1064 HTB 14M	1064
1190 HTB 14M	1190
1344 HTB 14M	1344
1400 HTB 14M	1400
1456 HTB 14M	1456
1512 HTB 14M	1512
1540 HTB 14M	1540
1610 HTB 14M	1610
1764 HTB 14M	1764
1778 HTB 14M	1778
1890 HTB 14M	1890
2100 HTB 14M	2100
2310 HTB 14M	2310
2450 HTB 14M	2450
2590 HTB 14M	2590
2800 HTB 14M	2800
3150 HTB 14M	3150
3360 HTB 14M	3360
3500 HTB 14M	3500
3850 HTB 14M	3850
4326 HTB 14M	4326
4578 HTB 14M	4578
P 14	
H₁ 6,1	
H 10	

ISORAN OPEN-END
Rubber timing belt rolls



ISORAN RUBBER OPEN-END Timing belt



ISORAN RUBBER OPEN-END SYNCHRONOUS BELTS

Specially suitable for linear drives, accurate positioning and reversal drives.

A high load capacity, no maintenance cost and very low noise level, make this belt a perfect alternative to chain or cable reverse drives.

Megadyne Open-end rubber belts, produced both in straight and spiral cut, are available in the following profiles, pitches and constructions:

- ISORAN MXL; XL; L; H
- ISORAN RPP RPP3; RPP5; RPP8
- ISORAN RPP SILVER SLV5; SLV8
- ISORAN RPP STEEL RPP8; RPP14
- STD STD8

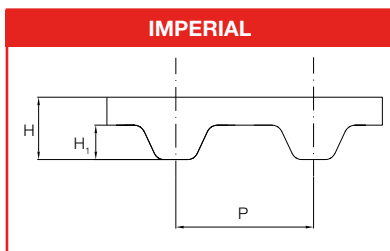

MXL	
Std. width (inches)	
	0,25
	0,31
	0,37
P	2,032
H	1,14
H ₁	0,51

XL	
Std. width (inches)	
	0,25
	0,31
	0,37
P	5,08
H	2,4
H ₁	1,27

L	
Std. width (inches)	
	0,50
	0,75
	1,00
P	9,525
H	3,8
H ₁	1,91

H	
Std. width (inches)	
	0,50
	0,75
	1,00
	1,50
	2,00
	3,00
P	12,7
H	4,4
H ₁	2,29

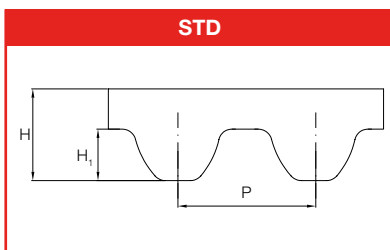

STD8	
Std. width (mm)	
	10
	12
	15
	20
	25
P	8
H	5,4
H ₁	3,05

RPP3	
Std. width (mm)	
	9
	12
	15
P	3
H	2,4
H ₁	1,15

RPP5	
Std. width (mm)	
	9
	12
	15
	20
	25
	30
P	5
H	3,8
H ₁	2

RPP8	
Std. width (mm)	
	10
	15
	20
	25
	30
	50
	85
P	8
H	5,4
H ₁	3,2

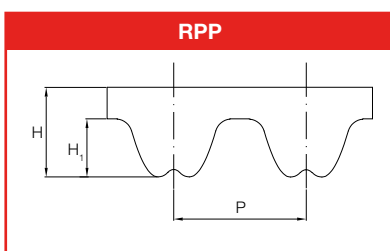

RPP STEEL 8	
Std. width (mm)	
	10
	15
	20
	30
	50
P	8
H	5,45
H ₁	3,2

RPP STEEL 14	
Std. width (mm)	
	25
	40
	55
	85
P	14
H	9,65
H ₁	6,3

SLV5	
Std. width (mm)	
	15
	25
P	5
H	3,8
H ₁	2

SLV8	
Std. width (mm)	
	10
	15
	20
	25
P	8
H	5,4
H ₁	3,2

MEGAPOWER
PU endless timing belts

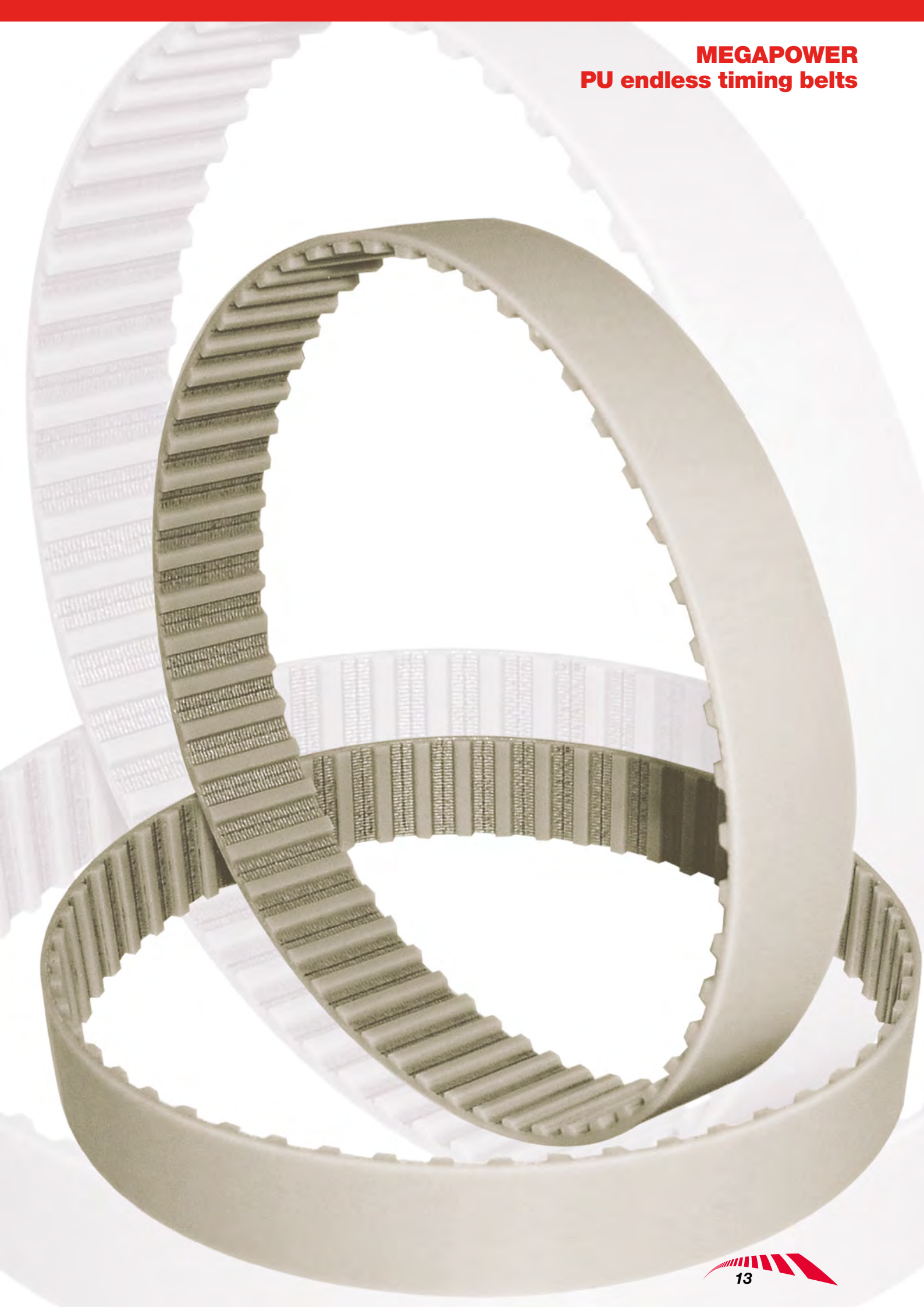

MEGAPOWER PU endless timing belts



MEGAPOWER timing belts are manufactured by a unique thermoset moulding process.

The high-grade polyurethane gives excellent abrasion and shear resistance, combined with a variety of graded steel cords, ensuring high strength and tractive resistance. The result is a timing belt with excellent dimensional stability. Megapower moulded timing belts are manufactured to a tight tolerance range, which assures consistent length and thickness.

The combination of these factors results in Megapower, performing to the highest physical and chemical levels.

MEGAPOWER belts perform especially well on light synchronised and stepped drives, in office automation and domestic appliance applications. To meet the needs of industry, Megadyne introduces **MEGAPOWER2**, a new generation of thermoset polyurethane timing belts.

Our unique new moulding process, combined with a high performance compound, ensures superior dynamic performance, more transmittable power and excellent dimensional stability. This translates to an extra 30% of Megapower2 performance:



MECHANICAL features

- Consistent dimensional stability
- Low pre-tension
- Low noise
- High abrasion resistance
- Low maintenance
- High flexibility
- Linear speeds up to 30 m/sec

CHEMICAL features

- Good resistance to aging, hydrolisis, UVA rays, ozone
- Working temperature: -25 °C to +80 °C (up to +110 °C for short periods)
- High resistance to oils, fats and greases
- Good resistance to most acids and Alkalis



MEGAPOWER FC are the new belts from Megadyne for the food processing industry, made with food contact approved materials according to European regulations EU 1935/2004, EU 10/2011 and EU 174/2015.

Main features:

- Resistance to most cleaning chemicals and humid, wet environments
- High acceleration, synchronizing and multi stop/start
- Easier belt wash-down
- Working temperature -25°C/+80°C



Standard range:

MEGAPOWER	T2; T2,5; T2,5 DD; MXL; XL; L; H
MEGAPOWER2	T5; T10; T5 DD; T10 DD; AT5; AT10
MEGAPOWER FC	L; H; T5; T10; T5 DD; T10 DD; AT10

MEGAPOWER PU endless timing belts

T2	
Std. width (mm)	
4/6/8/10/12	

T2	
Code	Pitch length (mm)
180	180
200	200
P	2
H	1,1
H _i	0,5

T2.5	
Std. width (mm)	
4/6/8/10/12	

T2.5	
Code	Pitch length (mm)
120	120
145	145
160	160
177,5	177,5
180	180
182,5	182,5
200	200
210	210
230	230
245	245
265	265
277,5	277,5
285	285
290	290
305	305
317,5	317,5
330	330
342,5	342,5
380	380
395	395
420	420
480	480
500	500
540	540
600	600
620	620
650	650
680	680
700	700
780	780
880	880
915	915
950	950
1185	1185
P	2,5
H	1,3
H _i	0,7

T5	
Std. width (mm)	
6/8/10/12/16/20/25	

T5	
Code	Pitch length (mm)
120	120
150	150
165	165
180	180
185	185
200	200
210	210
215	215
220	220
225	225
245	245
250	250
255	255
260	260
270	270
275	275
280	280
295	295
300	300
305	305
330	330
340	340
350	350
355	355
365	365
375	375
390	390
395	395
400	400
410	410
420	420
425	425
440	440
445	445
450	450
455	455
460	460
475	475
480	480
500	500
510	510
515	515
515*	515*
525	525
545	545
550	550
560	560
560*	560*
575	575
590	590
600	600
610	610
620	620
630	630
640	640
650	650
660	660
675	675
690	690
700	700
720	720
725	725
750	750
765	765
780	780
800	800
815	815
830	830
840	840
850	850
860	860
885	885
900	900
920	920
940	940
990	990
1000	1000
1075	1075
1100	1100
1160	1160
1200	1200
1215	1215
1275	1275
1280	1280
1315	1315
1355	1355
1380	1380
1440	1440
1470	1470
1500	1500
1580	1580
1690	1690
1955	1955
P	5
H	2,2
H _i	1,2

T10	
Std. width (mm)	
10/12/16/20/25/32/50/75	

T10	
Code	Pitch length (mm)
260	260
320	320
340	340
370	370
390	390
400	400
410	410
440	440
450	450
480	480
500	500
530	530
550	550
560	560
600	600
600*	600*
610	610
630	630
630*	630*
650	650
660	660
680	680
690	690
700	700
720	720
720*	720*
730	730
750	750
780	780
800*	800*
810	810
840	840
850	850
880	880
890	890
900	900
900*	900*
910	910
920	920
920*	920*
950	950
960	960
970	970
980	980
1000	1000
1010	1010
1050	1050
1080	1080
1100	1100
1110	1110
1140	1140
1150	1150
1200	1200
1210	1210
1240	1240
1250	1250
1300	1300
1320	1320
1350	1350
1390	1390
1400	1400
1420	1420
1440	1440
1450	1450
1460	1460
1500	1500
1560	1560
1600	1600
1610	1610
1700	1700
1750	1750
1780	1780
1800	1800
1880	1880
1960	1960
2250	2250
P	10
H	4,5
H _i	2,5

T2.5 DD	
Std. width (mm)	
4/6/8/10/12	

T2.5 DD	
Code	Pitch length (mm)
457,5 DD	457,5
P	2,5
H	1,9
H _i	0,7

T5 DD	
Std. width (mm)	
6/8/10/12/16/20/25	

T5 DD	
Code	Pitch length (mm)
410 DD	410
460 DD	460
515 DD	515
525 DD	525
550 DD	550
590 DD	590
620 DD	620
650 DD	650
685 DD	685
700 DD	700
750 DD	750
815 DD	815
840 DD	840
860 DD	860
940 DD	940
1100 DD	1100
P	5
H	3,40
H _i	1,2

T10 DD	
Std. width (mm)	
10/12/16/20/25/32/50/75	

T10 DD	
Code	Pitch length (mm)
260 DD	260
530 DD	530
630 DD	630
660 DD	660
700 DD	700
720 DD	720
800 DD	800
840 DD	840
900 DD	900
920 DD	920
980 DD	980
1010 DD	1010
1100 DD	1100
1150 DD	1150
1210 DD	1210
1240 DD	1240
1250 DD	1250
1320 DD	1320
1350 DD	1350
1420 DD	1420
1500 DD	1500
1610 DD	1610
1800 DD	1800
1880 DD	1880
P	10
H	7
H _i	2,5

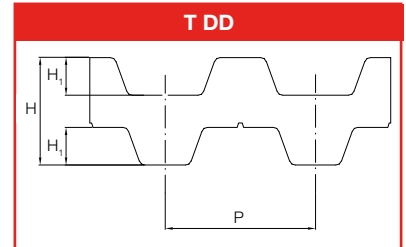
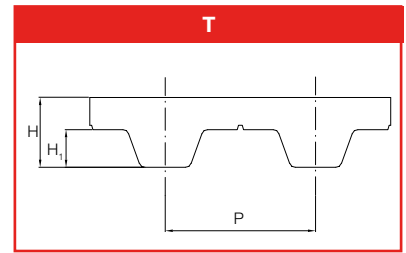

* Without gap

MEGAPOWER

PU endless timing belts

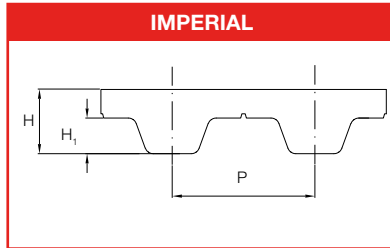
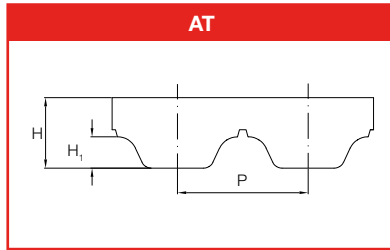

AT5	
Std. width (mm)	
6/8/10/12/16/20/25	

AT5	
Code	Pitch length (mm)
225	225
255	255
275	275
280	280
300	300
330	330
340	340
375	375
390	390
420	420
450	450
455	455
480	480
500	500
525	525
545	545
600	600
610	610
620	620
630	630
660	660
670	670
710	710
720	720
750	750
780	780
825	825
860	860
975	975
1050	1050
1125	1125
1500	1500
2000	2000
P	5
H	2,7
H₁	1,2

AT10	
Std. width (mm)	
10/12/16/20/25/32/50/75	

AT10	
Code	Pitch length (mm)
370	370
500	500
560	560
580	580
600	600
610	610
630	630
660	660
700	700
730	730
780	780
800	800
810	810
840	840
880	880
890	890
920	920
960	960
980	980
1000	1000
1010	1010
1050	1050
1080	1080
1100	1100
1150	1150
1190	1190
1200	1200
1210	1210
1220	1220
1230	1230
1240	1240
1250	1250
1280	1280
1300	1300
1320	1320
1350	1350
1360	1360
1400	1400
1420	1420
1480	1480
1500	1500
1600	1600
1630	1630
1700	1700
1720	1720
1800	1800
1860	1860
1940	1940
P	10
H	4,8
H₁	2,5

MXL	
Std. width (mm)	
3,2/4,8/6,4	

MXL	
Code	Pitch length (mm)
44	111,7
45,6	115,8
48	121,9
56	142,2
57,6	146,3
60	152,4
60,8	154,4
63,2	160,5
64	162,5
65,6	166,6
70,4	178,8
72,8	184,9
73,6	186,9
76,8	195,1
78,4	199,1
80,8	205,2
81,6	207,2
82,4	209,2
84	213,3
88	223,5
91,2	231,6
94,4	239,7
96	243,8
97,6	247,9
104	264,1
105,6	268,2
108	274,3
112	284,4
116	294,6
120	304,8
124	314,9
140	355,6
152	386,1
160	406,4
176,8	449,1
204,8	520,1
224	568,9
228	579,1
246,4	625,8
252	640,0
260	660,4
265,6	674,6
281,6	715,2
288	731,5
316	802,6
324	822,9
329,6	837,1
345,6	877,8
363,2	922,5
388	985,5
P	2,032
H	1,2
H₁	0,51

XL	
Std. width (mm)	
6,4/7,9/9,4	

XL	
Code	Pitch length (mm)
60	152,4
70	177,8
76	193,0
80	203,2
90	228,6
100	254,0
110	279,4
120	304,8
130	330,2
134	340,3
140	355,6
150	381,0
160	406,4
170	431,8
180	457,2
190	482,6
194	492,7
200	508,0
210	533,4
220	558,8
230	584,2
240	609,6
250	635,0
260	660,4
270	685,8
288	731,5
290	736,6
300	762,0
356	904,2
414	1051,5
450	1143,0
566	1437,6
P	5,08
H	2,3
H₁	1,27

L	
Std. width (mm)	
12,7/19,1/25,4	

L	
Code	Pitch length (mm)
86	218,6
124	314,3
150	381,0
173	438,2
187	476,2
202	514,4
210	533,4
225	571,5
240	609,6
255	647,7
270	685,8
285	723,9
300	762,0
322	819,2
345	876,3
367	933,4
390	990,6
420	1066,8
450	1143,0
480	1219,2
510	1295,4
540	1371,6
570	1447,8
600	1524,0
P	9,525
H	3,6
H₁	1,9

H	
Std. width (mm)	
19,1/25,4/38,1/50,8/76,2	

H	
Code	Pitch length (mm)
230	584,2
240	609,6
270	685,8
300	762,0
330	838,2
360	914,4
390	990,6
420	1066,8
450	1143,0
480	1219,2
510	1295,4
P	12,7
H	4,3
H₁	2,29

MEGAFLEX
PU truly endless timing belts

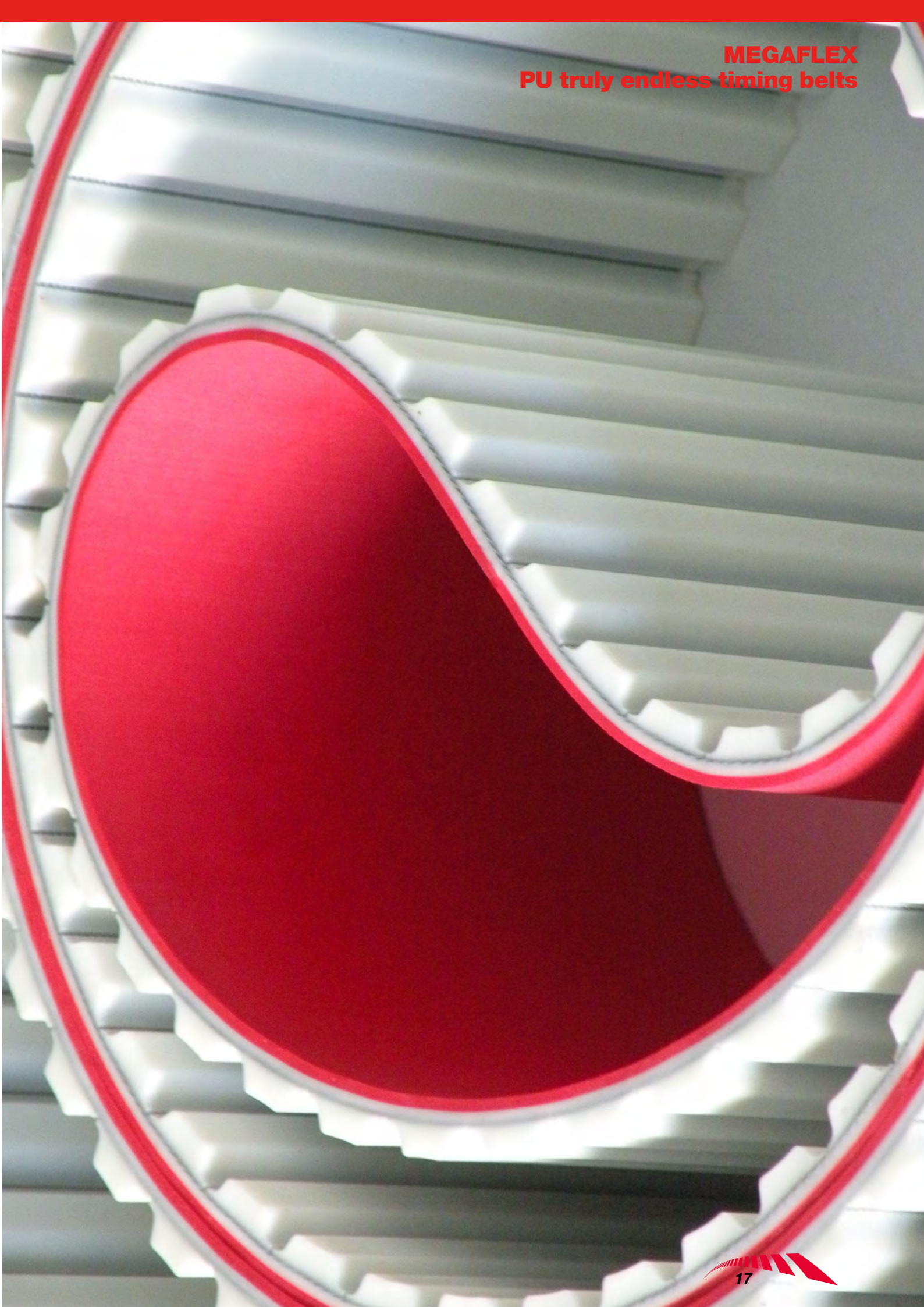

MEGAFLEX PU truly endless timing belts



MEGAFLEX timing belts are manufactured in thermoplastic polyurethane, with continuous spiral steel cords.

This type of belt, developed by our Research & Development, offers good running characteristics and high traction loads.

They are especially suited for power transmission and conveying with high loads and high speeds (up to 10.000 RPM).

The addition of a nylon coating on the teeth during production enhances the running properties for specific applications and reduces the noise frictional coefficient.

An extra thickness of special coating is also possible on the back of the belt offering extra protection against aggressive or heavy products.

MEGAFLEX belts are truly endless, enabling them to deliver exceptional performance.

Megadyne **MEGAFLEX** timing belts are available from 1.500 Up to 22.770 mm length.

MEGAFLEX Special constructions

- High flex cords
- (NFT) nylon fabric on the teeth (available from 1.900 mm length)
- Custom milling, grinding and drilling to specification
- Additional continuous coatings on the back of the belt in:
 - PU 85° ShA
 - Tenax 50° ShA
 - Linatex 40° ShA
 - Yellow PUR 60° ShA
 - Grey PUR 60° ShA
 - Neoprene rubber 70° ShA

Other hardnesses available on request.

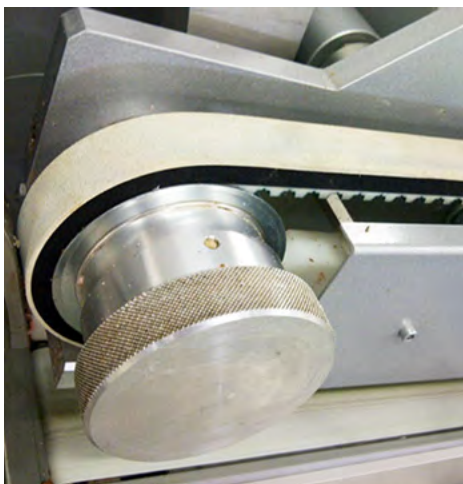

MEGAFLEX PU truly endless timing belts

XL/XLDD	
Std. width (mm)	
12,7	
19,05	
25,4	
38,1	
50,8	
76,2	
101,6	
152,4	
P	5,08
H	2,3
H _i	1,27
H _t	3,05

L/LDD	
Std. width (mm)	
12,7	
19,05	
25,4	
38,1	
50,8	
76,2	
101,6	
152,4	
P	9,525
H	3,6
H _i	1,9
H _t	4,58

H/HDD	
Std. width (mm)	
12,7	
19,05	
25,4	
38,1	
50,8	
76,2	
101,6	
152,4	
P	12,7
H	4,3
H _i	2,29
H _t	5,95

XH/XHDD	
Std. width (mm)	
25,4	
38,1	
50,8	
76,2	
101,6	
152,4	
P	22,225
H	11,2
H _i	6,35
H _t	15,49

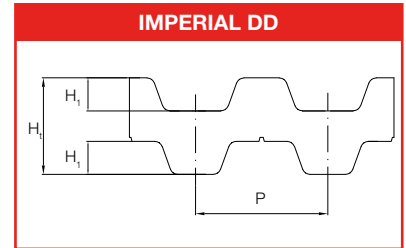
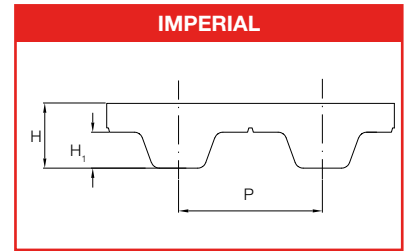

T5/T5DD	
Std. width (mm)	
10	
16	
25	
32	
50	
75	
100	
150	
P	5
H	2,2
H _i	1,2
H _t	3,4

T10/T10DD	
Std. width (mm)	
12	
16	
25	
32	
50	
75	
100	
150	
P	10
H	4,5
H _i	2,5
H _t	7

T20/T20DD	
Std. width (mm)	
25	
32	
50	
75	
100	
150	
P	20
H	8
H _i	5
H _t	13

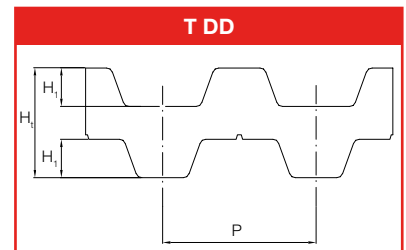
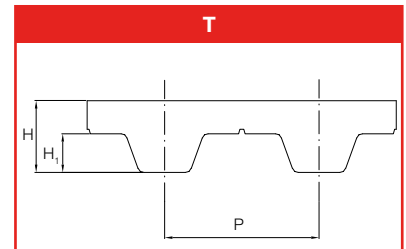

AT5/AT5DD	
Std. width (mm)	
10	
16	
25	
32	
50	
75	
100	
150	
P	5
H	2,7
H _i	1,2
H _t	3,9

AT10/AT10DD	
Std. width (mm)	
12	
16	
25	
32	
50	
75	
100	
150	
P	10
H	4,5
H _i	2,5
H _t	7

AT15	
Std. width (mm)	
32	
50	
75	
100	
150	
P	15
H	6,3
H _i	3,8

AT20/AT20DD	
Std. width (mm)	
25	
32	
50	
75	
100	
150	
P	20
H	8
H _i	5
H _t	13

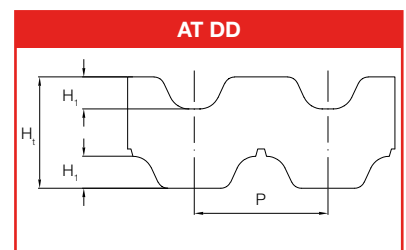
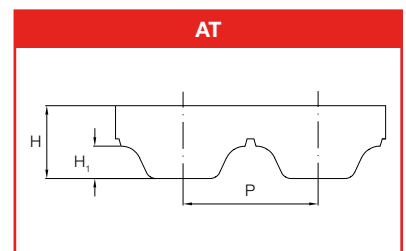

MEGAFLEX

PU truly endless timing belts

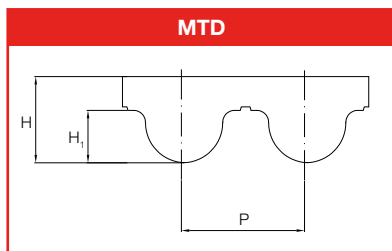

MTD 8M	
Std. width (mm)	
15	
20	
30	
50	
85	
100	
150	
P	8
H	5,6
H ₁	3,4

ATG10 K13	
Std. width (mm)	
25	
32	
50	
75	
100	
150	
P	10
H	4,5
H ₁	2,5
B	13
h	9

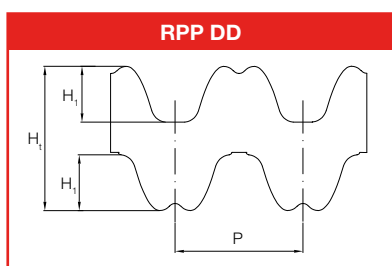
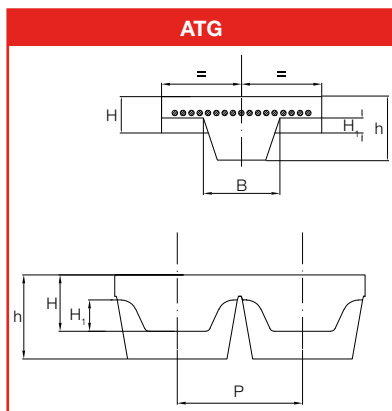

RPP5/RPP5DD	
Std. width (mm)	
10	
15	
25	
30	
50	
85	
100	
150	
P	5
H	3,8
H ₁	2
H _t	5,2

RPP8/RPP8DD	
Std. width (mm)	
15	
20	
30	
50	
85	
100	
150	
P	8
H	5,4
H ₁	3,2
H _t	7,8

RPP14/RPP14DD	
Std. width (mm)	
25	
40	
55	
85	
115	
150	
P	14
H	10
H ₁	6
H _t	14,5

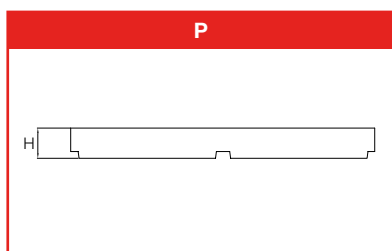
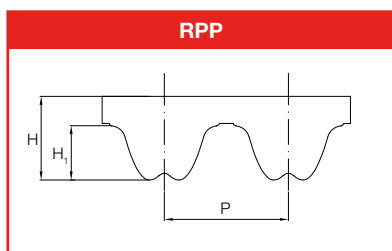

P2	
Std. width (mm)	
25	
50	
75	
100	
150	
P	2

MEGALINEAR
PU open-end timing belts



MEGALINEAR

PU open-end timing belts



MEGALINEAR open end timing belts are manufactured in thermoplastic polyurethane, that gives superior wear and abrasion resistance.

Various grades of steel cords offer good running characteristics, even with high tractive loads. Manufactured to tight tolerances, **MEGALINEAR** delivers reliability and excellent dimensional stability. The addition of a Nylon coating on the tooth and/or the back of the belt during production, enhances the running properties for specific applications. An extra thickness of polyurethane is also possible on the back of the belt, offering extra protection against aggressive or heavy products.

MEGALINEAR offers the following features:

MECHANICAL features

- Consistent dimensional stability
- Low pre-tension
- Low noise
- High abrasion resistance
- Low maintenance
- High flexibility
- Linear speeds up to 80 m/sec
- High precision linear positioning

CHEMICAL features

- Good resistance to Aging,
- Hydrolysis,
- UVA rays,
- Ozone
- Working temperature: -25 °C to +80 °C (up to +110 °C for short periods)
- High resistance to oils, fats and greases
- Good resistance to most acids and Alkalis
- Compatible for fabrication with other thermoplastic materials

MEGALINEAR can be supplied as open length rolls, (standard roll length is 100 metres) or as endless jointed belts, available in a wide range of solutions with numerous tooth design: Imperial profile, metric profile with or without guide, parabolic profile, flat...

MEGALINEAR is also available with alternative reinforcement cords such as, Kevlar (K), High Flex (HF), High Performance (HP) and High Performance Flex (HPF).

Megadyne has expanded its range of Megalinear with the new belts: Megalinear QST, Megalinear GW and Megalinear FC.

Specifically designed to reduce the noise level generated during high speed operation, the **MEGALINEAR QST** is completely self-tracking, there is no need for flanges on the pulleys. The nylon faced helical offset teeth provide a high torque capacity.

For heavy applications, Megadyne introduce the **MEGALINEAR GW**, a high performance thermoplastic Polyurethane belt. Superior load capacities can be achieved, due to the high shear strength of the tooth design, coupled with high tension, steel zinc coated cords. Megalinear GW guarantees a greater transmittable power under continuous high loads.

MEGALINEAR FC belts match the power and precision for synchronous conveying meeting the criteria where food contact is required. These belts guarantee zero risk of slippage, even in greasy and humid environment, and zero risk of fraying and detaching of back profile.



MEGALINEAR PU open-end timing belts

MXL		XL		L	
Std. width (inches)		Std. width (inches)		Std. width (inches)	
	0,17		0,25		0,37
	0,37		0,37		0,50
	0,50		0,50		0,75
			0,75		1,00
			1,00		1,50
			1,50		2,00
			2,00		4,00
P	2,032	P	5,08	P	9,525
H	1,14	H	2,3	H	3,6
H _i	0,66	H _i	1,27	H _i	1,90

H		H*		XH	
Std. width (inches)		Std. width (inches)		Std. width (inches)	
	0,50		8,00		1,00
	0,75		10,00		1,50
	1,00		12,00		2,00
	1,50		16,00		3,00
	2,00		20,00		4,00
	3,00				6,00
	4,00				
	6,00				
P	12,7	P	12,7	P	22,225
H	4,3	H	4,3	H	11,2
H _i	2,29	H _i	2,29	H _i	6,35

T2.5		T5		T5*		T10	
Std. width (mm)		Std. width (mm)		Std. width (mm)		Std. width (mm)	
	10		6		250		12
	16		10		500		16
	20		16				25
			25				32
			32				50
			50				75
			75				100
			100				150
			150				
P	2,5	P	5	P	5	P	10
H	1,3	H	2,2	H	2,20	H	4,5
H _i	0,7	H _i	1,2	H _i	1,2	H _i	2,5

T10*		T10 without gap		T20	
Std. width (mm)		Std. width (mm)		Std. width (mm)	
	200		16		25
	250		25		32
	300		32		50
	400		50		75
	450		75		100
	500				150
P	10	P	10	P	20
H	4,5	H	4,5	H	8
H _i	2,5	H _i	2,5	H _i	5

AT3		AT5		AT10		AT10 without gap		MEGAC4T™ AT10		AT20	
Std. width (mm)		Std. width (mm)		Std. width (mm)		Std. width (mm)		Std. width (mm)		Std. width (mm)	
	10		6		16		25		25		25
	20		10		25		32		50		32
	25		16		32		50		75		50
	50		25		50		75		100		75
			32		75		100				100
			50		100						150
			75		150						200
			100								
P	3	P	5	P	10	P	10	P	10	P	20
H	1,9	H	2,7	H	4,5	H	4,5	H	4,5	H	8
H _i	1,1	H _i	1,2	H _i	2,5	H _i	2,5	H _i	2,5	H _i	5

RPP5		RPP8		RPP14		RPP14 XHP	
Std. width (mm)		Std. width (mm)		Std. width (mm)		Std. width (mm)	
	10		10		40		40
	15		15		55		55
	25		20		85		85
	30		30		115		115
	50		50		150		150
	75		85				
			100				
P	5	P	8	P	14	P	14
H	3,8	H	5,4	H	10	H	10,2
H _i	2	H _i	3,2	H _i	6	H _i	6

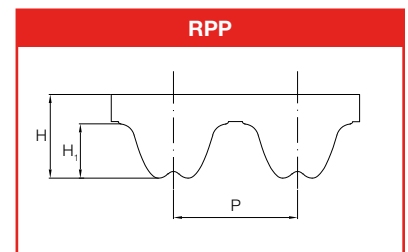
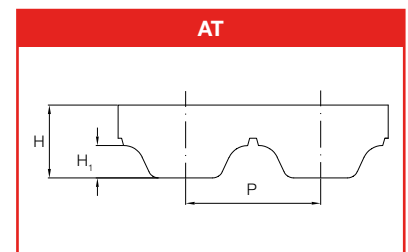
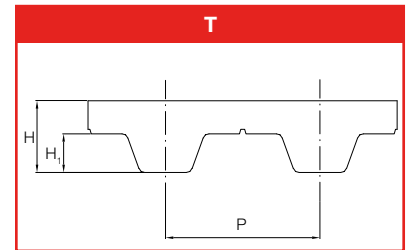
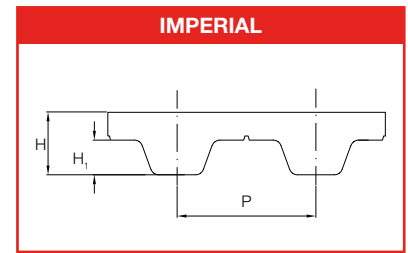

* Only with kevlar cords and reduced number of cords

MEGALINEAR

PU open-end timing belts

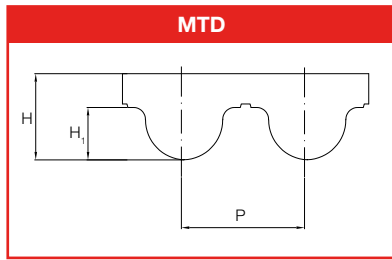

MTD 3	
Std. width (mm)	
10	
20	
25	
50	
P	3
H	2,2
H ₁	1,13

MTD 5	
Std. width (mm)	
10	
15	
25	
50	
P	5
H	3,6
H ₁	2,1

MTD 8	
Std. width (mm)	
10	
15	
20	
30	
50	
85	
100	
P	8
H	5,6
H ₁	3,4

MTD 14	
Std. width (mm)	
25	
40	
55	
85	
100	
115	
P	14
H	10
H ₁	6,1

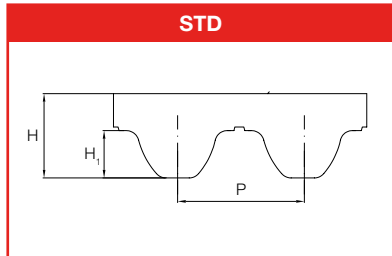

STD 5	
Std. width (mm)	
10	
15	
25	
50	
75	
100	
150	
P	5
H	3,4
H ₁	1,91

STD 8	
Std. width (mm)	
10	
12	
15	
20	
30	
50	
85	
P	8
H	5,1
H ₁	3,05

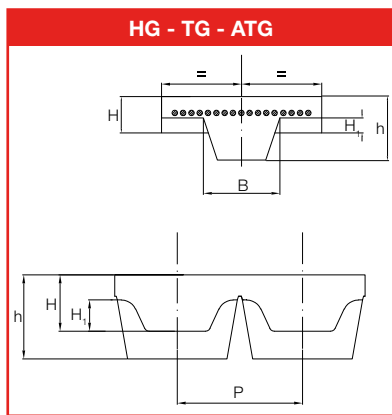

TG5	
Std. width (mm)	
25	
32	
50	
P	5
H	2,2
H ₁	1,2
B	6
h	5

TG10 K6	
Std. width (mm)	
50	
P	10
H	4,5
H ₁	2,5
B	6
h	5,3

TG10 K13	
Std. width (mm)	
25	
32	
50	
75	
100	
P	10
H	4,5
H ₁	2,5
B	13
h	8,5

TG20	
Std. width (mm)	
50	
75	
100	
P	20
H	8
H ₁	5
B	13
h	8,5

ATG5	
Std. width (mm)	
25	
32	
50	
P	5
H	2,7
H ₁	1,2
B	6
h	5,5

ATG10 K6	
Std. width (mm)	
50	
P	10
H	4,5
H ₁	2,5
B	6
h	5,3

ATG10 K13	
Std. width (mm)	
25	
32	
50	
75	
100	
150	
P	10
H	4,5
H ₁	2,5
B	13
h	8,5

ATG20	
Std. width (mm)	
75	
150	
P	20
H	8
H ₁	5
B	13
h	9,4

HG	
Std. width (inch)	
1,50	
2,00	
3,00	
4,00	
6,00	
P	12,7
H	4,3
H ₁	2,29
B	13
h	8,5

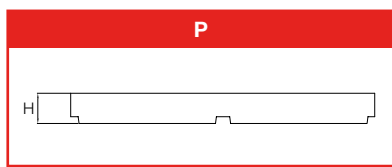

P1	
Std. width (mm)	
10	
20	
H	1

P2	
Std. width (mm)	
25	
50	
75	
100	
H	2

P3	
Std. width (mm)	
30	
60	
100	
120	
H	3,2

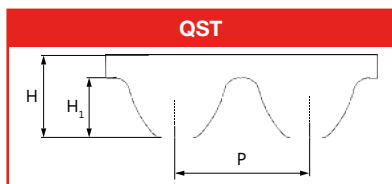

QST 5	
Std. width (mm)	
12	
24	
P	5
H	3,6
H ₁	1,91

QST 8	
Std. width (mm)	
16	
25	
32	
50	
P	8
Steel cord	5,33
HP cord	5,60
H ₁	3,05

QST 14	
Std. width (mm)	
35	
52,5	
70	
105	
P	14
Steel cord	8,64
XHP cord	9
H ₁	5,33

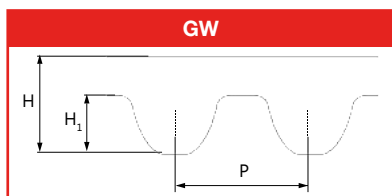

GW 14	
Std. width (mm)	
50	
100	
150	
200	
P	14
H	10
H ₁	6

GW 20	
Std. width (mm)	
50	
100	
150	
200	
P	20
H	14,3
H ₁	8,57

MEGAFLAT
PU and Rubber endless flat belts



MEGAFLAT

PU and Rubber endless flat belts



MEGAFLAT belts are truly endless mandrel moulded, available in both polyurethane or chloroprene rubber, with either polyester, aramide or cotton reinforcements.

MEGAFLAT features:

- High flexibility
- Small pulley diameters
- Dimensional accuracy
- High speed
- Energy efficient
- Low noise and vibration
- Low maintenance
- Good chemical and ozone resistance
- High friction surface

MEGAFLAT belts are particularly suitable for both power transmission and conveying.

RUBBER

	T 75	T 108	T110	T120
Tensile reinforcement	Polyester fabric	Polyester/Cotton	Polyester	Polyester
Installation tension x cm width (N) endless	150	260	270	350
Min. Pulley dia. mm	6	10	15	20
Thickness mm	0,5	0,65	0,9	1,4
Standard length mm	200/3850	200/3850	200/3850	470/3850
Coating material	NEOPRENE	NEOPRENE	NEOPRENE	NEOPRENE
Antistatic	YES	YES	YES	YES

	T 150	T 155	T 200
Tensile reinforcement	Polyester	Polyester / Aramid	Polyester fabric
Installation tension x cm width (N) endless	300	500	400
Min. Pulley dia. mm	15	30	20
Thickness mm	0,9	1,6	1,1
Standard length mm	200/3850	470/3850	200/3850
Coating material	NEOPRENE	NEOPRENE	NEOPRENE
Antistatic	YES	YES	YES

POLYURETHANE

	P 0	P 102
Tensile reinforcement	No fabric	Elastic
Installation tension x cm width (N) endless	-	10
Min. Pulley dia. mm	8	25
Thickness mm	0,9	1,8*
Standard length mm	210/2500	210/2500
Coating material	NO	POLYURETHANE/ SILICONE
Antistatic	NO	POSSIBLE

	P 108	P 110	P 120	P 155
Tensile reinforcement	Polyester / cotton	Polyester fabric	Polyester fabric	Aramid/polyester
Installation tension x cm width (N) endless	200	150	300	350
Min. Pulley dia. mm	8	12	20	30
Thickness mm	0,8*	1,0*	1,5*	2*
Standard length mm	210/3850	210/3850	210/4300	210/4300
Coating material	POLYURETHANE/ SILICONE	POLYURETHANE/ SILICONE	POLYURETHANE/ SILICONE	POLYURETHANE/ SILICONE
Antistatic	POSSIBLE	POSSIBLE	POSSIBLE	POSSIBLE

	S 108	S 110	S 120	S 155
Tensile reinforcement	Polyester / cotton	Polyester	Polyester	Aramid/ polyester
Installation tension x cm width (N) endless	180	125	350	400
Min. Pulley dia. mm	8	12	20	25
Thickness mm	0,8*	1,0*	1,5*	2,0*
Standard length mm	210/3850	210/3850	210/4300	210/3800
Coating material	POLYURETHANE/ SILICONE	POLYURETHANE/ SILICONE	POLYURETHANE/ SILICONE	POLYURETHANE/ SILICONE
Antistatic	POSSIBLE	POSSIBLE	POSSIBLE	POSSIBLE

*Increase of thickness by about 0,3/0,5 mm for belts coated both sides.

V-BELTS

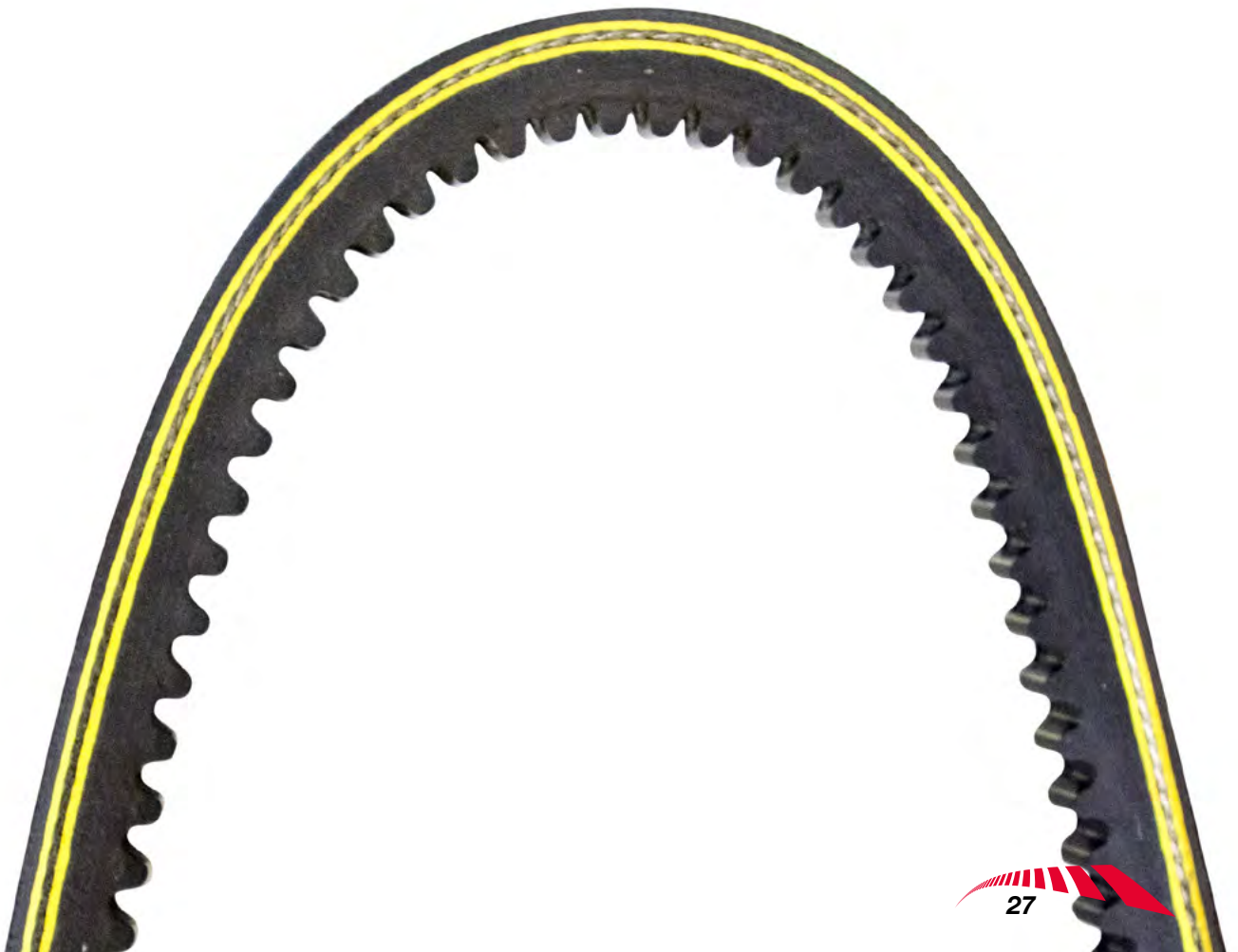

EXTRA - OLEOSTATIC - OLEOSTATIC GOLD
ESAFLEX - XDV2 - PLURIBAND
Rubber wrapped V-Belts

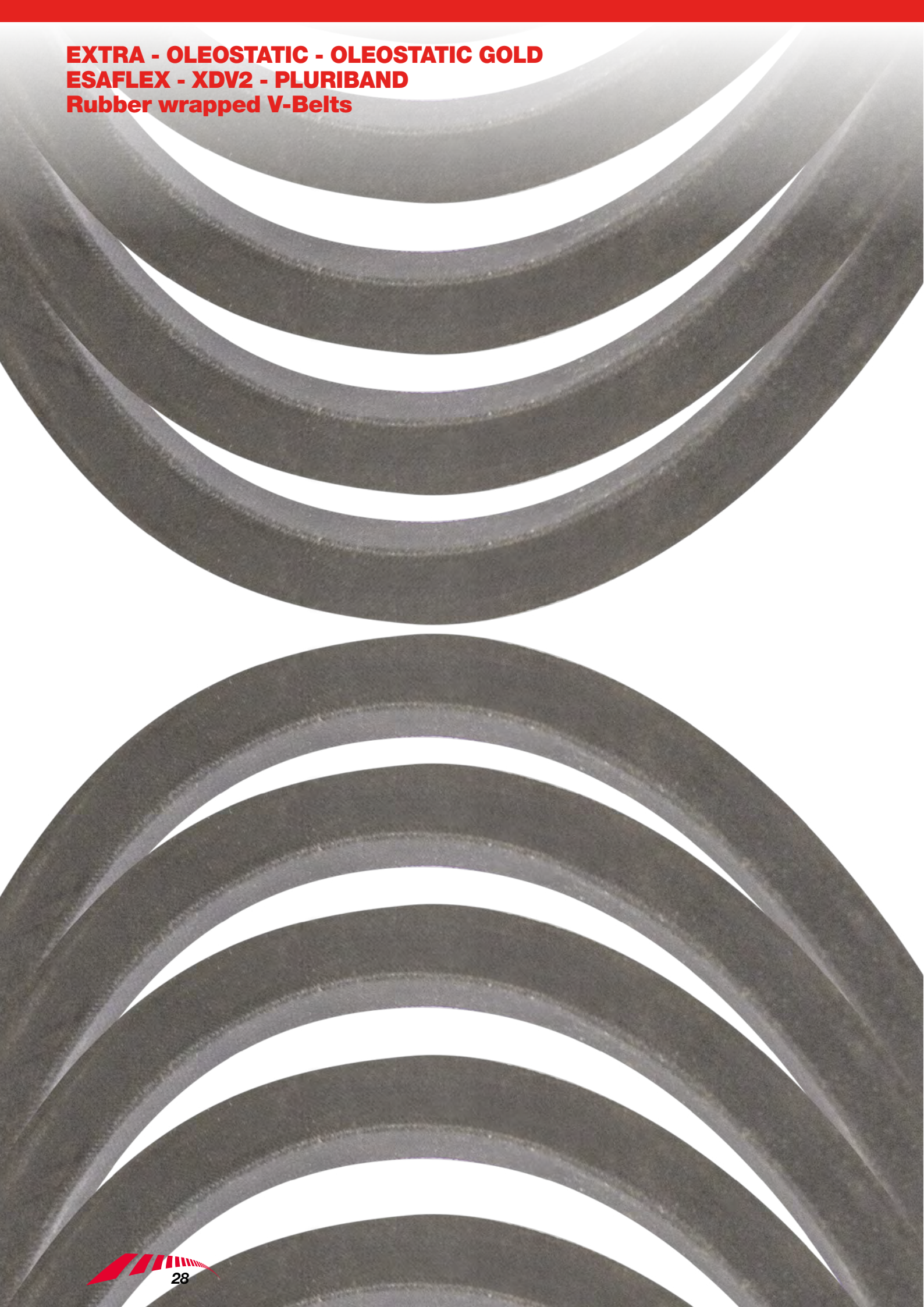

EXTRA - OLEOSTATIC - OLEOSTATIC GOLD ESAFLEX - XDV2 PLURIBAND Rubber wrapped V-Belts



WRAPPED V-belts are manufactured in polybutadiene compound.

High variety of belt sizes available permits the application of Megadyne V-belts on all types of industrial equipments. Applied technology allows to reach so good dimensional precision in V-belts to make them suitable for multiple transmissions. This dimensional stability continues also during belt use.

MECHANICAL features

- Smooth starting and running
- Wide range of driven speeds, using standard electric motors
- Low maintenance
- High efficient
- No need for lubrication
- Extremely wide horsepower ranges
- Dampen vibration between driver and driven pulleys
- Silent operations
- Long service life
- Easy installation
- Reduction in drive dimension

EXTRA

Extra belts were designed to offer durable and reliable performances on light and medium-duty drives. They represent an affordable solution for transmission systems of all industrial sectors.

OLEOSTATIC

Oleostatic rubber belts are developed with high resistant tensile elements, they are characterised by high performances, length stability during belts life, conductivity, oil and heat resistance. They are particularly suitable for centrifugal pumps, compressor, tool machines, generators, high power mills and stone mills.

OLEOSTATIC GOLD

Different materials and design features, together with an improved production process, have led to the development of a new class of higher rated wrapped V-belts. The new OLEOSTATIC GOLD V-belts product family can operate in a wide range of industrial applications, within a large spread of load capacities and speeds - offering rated performance from 100 to 8,000 RPM and power capability from 1 to 400 kW, meanwhile granting large cost advantages for the end users.

MEGAMATCH MEGA MATCH

All Oleostatic and Extra V-belts carrying the MEGA MATCH logo are made and supplied according to the matching set tolerances and limits indicated by the relevant international standards (ISO, RMA, etc)

ESAFLEX

Esaflex are ideally suited for serpentine drives where power needs to be transmitted equally from both sides of the belt. Double wrapped cotton neoprene cover is added for excellent resistance to abrasive wear, heat, ozone, sunlight, grease oil or dirt. Centrally located cord and special synthetic rubber compounds assure long belt life and a smooth drive.

XDV2 BELTS

The XDV2 belts has been created for drives with small pulley diameters and high temperature peaks, combined with a high grade of moisture and humidity. It withstands the harshest environmental requirements, such as oil and grease contaminated drives or transmissions where grits may interfere between pulleys and belt.

Thanks to its characteristics, the XDV2 perfectly matches the requirements of clutching drives as the aramid cords protect the belt against shock loads while maintaining its length constant.

PLURIBAND

Banded version of V-Belts eliminates belt whip and turnover on wedge-type drives. Patented bending process insures smooth operation. Oil and heat resistant, static dissipating.

Special constructions are available on request.

EXTRA - OLEOSTATIC GOLD Rubber wrapped V-Belts

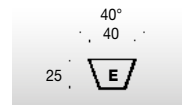
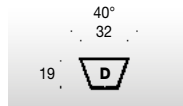
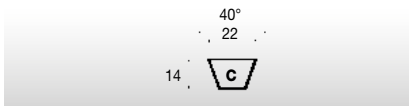

SECTION C	
Code	Internal length L1 (mm)
Extra and Oleostatic Gold	
C 33 3/4	858
C 37 1/2	950
C 39 3/4	1013
C 43	1090
C 45	1150
C 46	1168
C 47	1194
C 48	1220
C 49	1250
C 51	1295
C 52	1320
C 53	1350
C 54	1372
C 55	1400
C 56	1425
C 57	1450
C 58	1473
C 59	1500
C 60	1524
C 61	1560
C 62	1576
C 62 1/4	1583
C 63	1600
C 65	1650
C 66	1676
C 67	1700
C 68	1727
C 69	1753
C 70	1778
C 71	1798
C 72	1829
C 73	1854
C 74	1879
C 75	1900
C 76	1930
C 77	1955
C 78	1978
C 79	2005
C 80	2032
C 81	2057
C 82	2080
C 83	2108
C 83 1/2	2121
C 84	2134
C 85	2159
C 86	2184
C 87	2208
C 88	2235
C 89	2261
C 90	2286
C 92	2337
C 93	2360
C 94	2388
C 95	2413
C 96	2438
C 96 1/2	2450
C 97	2462
C 97 1/2	2477
C 98	2500
C 99	2525
C 100	2540
C 101	2560
C 102	2591
C 104	2642
C 105	2667
C 106	2692
C 108	2750
C 110	2800
C 111	2818
C 112	2845
C 112 1/2	2858
C 114	2888
C 115	2921
C 116	2950
C 117	2965
C 118	3000
C 120	3048
C 122	3099
C 124	3150
C 126	3200
C 128	3250
C 130	3302
C 132	3350
C 134	3404
C 136	3456

SECTION C	
Code	Internal length L1 (mm)
C 138	3498
C 140	3550
C 142	3607
C 144	3658
C 147	3733
C 148	3750
C 150	3808
C 153	3902
C 158	4000
C 160	4064
C 161 1/2	4100
C 162	4115
C 165	4193
C 166	4216
C 167	4242
C 168	4267
C 170	4318
C 173	4394
C 175	4445
C 177	4500
C 180	4572
C 187	4750
C 190	4826
C 195	4953
C 197	5000
C 204	5182
C 208	5300
C 210	5334
C 216	5486
C 220	5550
C 222	5600
C 225	5678
C 228	5753
C 236	6000
C 238	6045
C 240	6062
C 248	6263
C 250	6300
C 255	6438
C 264	6670
C 265	6700
C 270	6822
C 276	6973
C 280	7100
C 285	7203
C 295	7493
C 297	7500
C 300	7582
C 303	7650
C 314	7976
C 315	7965
C 316	8000
C 320	8093
C 330	8382
C 336	8500
C 345	8723
C 360	9107
C 394	10000
C 420	10632
C 424	10733

SECTION D*	
Code	Internal length L1 (mm)
D 79	2010
D 98	2500
D 104	2650
D 110	2800
D 118	3000
D 120	3048
D 124	3150
D 128	3251
D 132	3435
D 134	3403
D 135	3429
D 136	3454
D 137	3475
D 140	3550
D 144	3658
D 148	3760
D 154	3914
D 158	4013
D 162	4115
D 167	4241
D 170	4310
D 173	4394
D 175	4445
D 177	4500
D 180	4572
D 187	4750
D 195	4953
D 197	5000
D 204	5182
D 205	5209
D 207	5259
D 208	5283
D 210	5334
D 220	5588
D 223	5600
D 225	5659
D 236	5940
D 238	6000
D 240	6039
D 248	6244
D 250	6294
D 255	6424
D 264	6650
D 266	6700
D 270	6804
D 280	7050
D 282	7100
D 285	7184
D 295	7425
D 298	7500
D 300	7565
D 314	7924
D 315	7950
D 316	7974
D 326	8224
D 330	8329
D 345	8709
D 354	8940
D 360	9090
D 374	9445
D 390	9849
D 394	10000
D 420	10624
D 441	11200
D 480	12139
D 510	12897
D 540	13659
D 600	15184

SECTION E*	
Code	Internal length L1 (mm)
E 180	4575
E 197	5000
E 210	5335
E 220	5600
E 226	5660
E 240	6015
E 248	6220
E 255	6400
E 270	6780
E 280	7100
E 285	7160
E 295	7500
E 300	7540
E 316	7950
E 330	8305
E 345	8685
E 354	9000
E 360	9065
E 394	9930
E 420	10600
E 441	11200
E 480	12115
E 492	12500
E 540	13635
E 600	15160

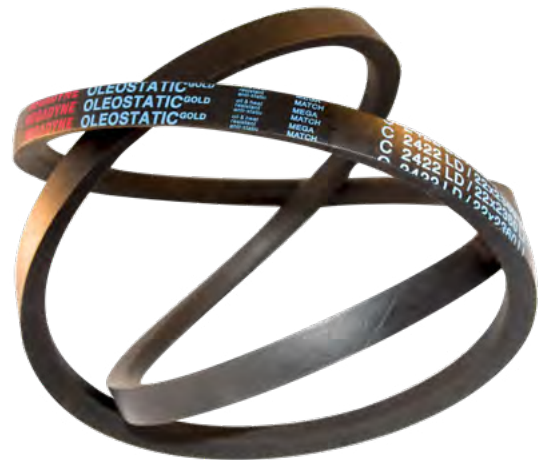

* Available only in Oleostatic GOLD version

OLEOSTATIC Rubber wrapped V-Belts

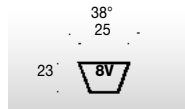
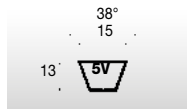
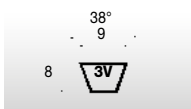

SECTION 3V	
Code	External length LE (mm)
3V 250	635
3V 265	675
3V 280	710
3V 300	760
3V 315	800
3V 335	850
3V 355	900
3V 375	955
3V 400	1015
3V 425	1080
3V 450	1145
3V 475	1205
3V 500	1270
3V 530	1345
3V 560	1420
3V 600	1525
3V 630	1600
3V 670	1700
3V 710	1805
3V 750	1905
3V 800	2030
3V 850	2160
3V 900	2285
3V 950	2415
3V 1000	2540
3V 1060	2690
3V 1120	2845
3V 1180	2995
3V 1250	3175
3V 1320	3355
3V 1400	3555
3V 1500	3810

SECTION 5V	
Code	External length LE (mm)
5V 500	1270
5V 530	1345
5V 560	1420
5V 600	1525
5V 630	1600
5V 670	1700
5V 710	1800
5V 750	1900
5V 800	2030
5V 850	2160
5V 900	2290
5V 950	2410
5V 1000	2540
5V 1060	2690
5V 1120	2840
5V 1180	3000
5V 1250	3180
5V 1320	3350
5V 1400	3550
5V 1500	3810
5V 1600	4060
5V 1700	4320
5V 1800	4570
5V 1900	4830
5V 2000	5080
5V 2120	5380
5V 2240	5690
5V 2360	6000
5V 2500	6350
5V 2650	6730
5V 2800	7100
5V 3000	7620
5V 3150	8000
5V 3350	8500
5V 3550	9000

SECTION 8V	
Code	External length LE (mm)
8V 1000	2540
8V 1060	2690
8V 1120	2840
8V 1180	3000
8V 1250	3180
8V 1320	3350
8V 1400	3550
8V 1500	3810
8V 1600	4060
8V 1700	4320
8V 1800	4570
8V 1900	4830
8V 2000	5080
8V 2120	5380
8V 2240	5690
8V 2360	6000
8V 2500	6350
8V 2650	6730
8V 2800	7100
8V 3000	7620
8V 3150	8000
8V 3350	8500
8V 3550	9000
8V 3750	9500
8V 4000	10160
8V 4250	10800
8V 4500	11430
8V 4750	12060
8V 5000	12700

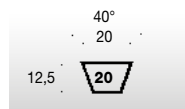

SECTION 20	
Code	Internal length LI (mm)
20	1800
20	1875
20	1900
20	1925
20	1950
20	2000
20	2050
20	2120
20	2200
20	2240
20	2360
20	2500
20	2600
20	2650
20	2800
20	3000
20	3150
20	3250
20	3350
20	3450
20	3550
20	3650
20	3750
20	4000
20	4250
20	4500
20	4750
20	5000
20	5300
20	5600
20	6000

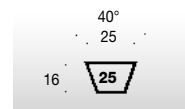

SECTION 25	
Code	Internal length LI (mm)
25	1800
25	1900
25	1950
25	2000
25	2050
25	2120
25	2200
25	2240
25	2325
25	2360
25	2450
25	2500
25	2650
25	2700
25	2800
25	2950
25	3000
25	3150
25	3300
25	3350
25	3550
25	3750
25	3950
25	4000
25	4250
25	4450
25	4500
25	4750
25	5000
25	5300
25	5600
25	5700
25	6000
25	6300
25	6500
25	6700
25	7100
25	7500
25	8000
25	8500
25	9000
25	9500
25	10000

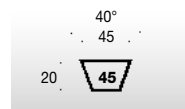

SECTION 45	
Code	Internal length LI (mm)
45	2000
45	2300
45	2500
45	2650
45	2750
45	2850
45	3000
45	3150
45	3250
45	3300
45	3500
45	3750
45	4000

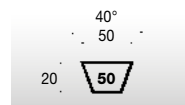

SECTION 50	
Code	Internal length LI (mm)
50	2000
50	2050
50	2150
50	2300
50	2500
50	2650
50	2750
50	2850
50	2870
50	3000
50	3150
50	3250
50	3300
50	3500
50	3670
50	3750
50	3950
50	4000



ESAFLEX

Rubber wrapped double V-Belts

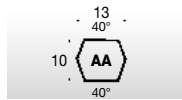
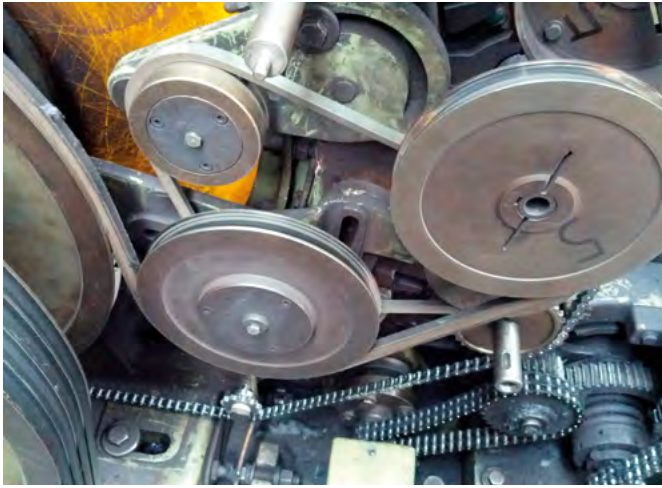

SECTION AA	
Code	Nominal length (mm)
AA 51	1350
AA 60	1580
AA 61	1600
AA 68	1780
AA 69	1805
AA 71	1855
AA 75	1955
AA 77	2010
AA 80	2085
AA 81	2110
AA 85	2210
AA 90	2340
AA 91	2365
AA 95	2465
AA 96	2490
AA 105	2720
AA 108	2800
AA 112	2895
AA 116	3000
AA 120	3100
AA 128	3305
AA 130	3355
AA 134	3455
AA 147	3785
AA 148	3810
AA 163	4195

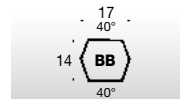

SECTION BB	
Code	Nominal length (mm)
BB 50	1345
BB 60	1600
BB 75	1980
BB 81	2130
BB 84	2210
BB 85	2235
BB 90	2360
BB 97	2540
BB 105	2745
BB 112	2920
BB 118	3075
BB 120	3125
BB 121	3150
BB 128	3325
BB 144	3735
BB 154	3990
BB 155	4015
BB 158	4090
BB 173	4470
BB 174	4495
BB 180	4650
BB 184	4750
BB 190	4900
BB 195	5030
BB 210	5410
BB 240	6135
BB 270	6895
BB 300	7660

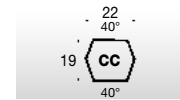

SECTION CC	
Code	Nominal length (mm)
CC 75	2010
CC 81	2160
CC 85	2265
CC 86	2290
CC 90	2390
CC 96	2545
CC 105	2770
CC 112	2950
CC 120	3150
CC 128	3355
CC 144	3760
CC 153	3990
CC 158	4120
CC 162	4220
CC 173	4500
CC 180	4680
CC 193	5010
CC 195	5060
CC 210	5440
CC 234	6000
CC 240	6155
CC 270	6910
CC 300	7675
CC 313	8000
CC 330	8435
CC 360	9200
CC 390	9960
CC 420	10720

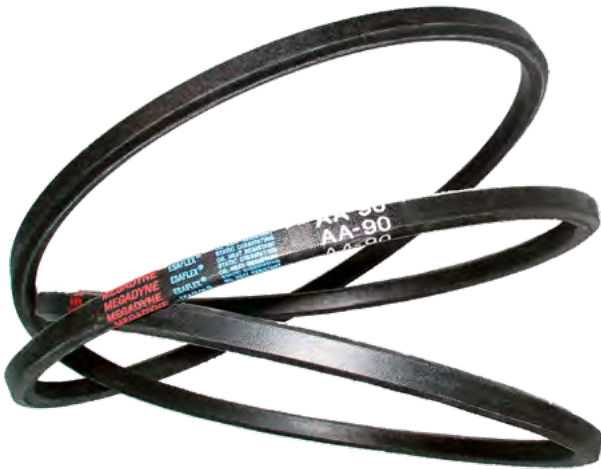

Rubber wrapped bare-back V-Belts

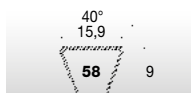
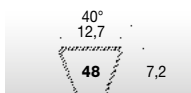
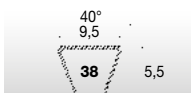

SECTION XDV2-38	
Code	External length LE (inches)
XDV 38/150	15
XDV 38/160	16
XDV 38/170	17
XDV 38/180	18
XDV 38/190	19
XDV 38/200	20
XDV 38/210	21
XDV 38/220	22
XDV 38/230	23
XDV 38/240	24
XDV 38/250	25
XDV 38/260	26
XDV 38/270	27
XDV 38/280	28
XDV 38/290	29
XDV 38/300	30
XDV 38/310	31
XDV 38/320	32
XDV 38/330	33
XDV 38/340	34
XDV 38/350	35
XDV 38/360	36
XDV 38/370	37
XDV 38/380	38
XDV 38/390	39
XDV 38/400	40
XDV 38/410	41
XDV 38/420	42
XDV 38/430	43
XDV 38/440	44
XDV 38/450	45
XDV 38/460	46
XDV 38/470	47
XDV 38/480	48
XDV 38/490	49
XDV 38/500	50
XDV 38/510	51
XDV 38/520	52
XDV 38/530	53
XDV 38/540	54
XDV 38/550	55
XDV 38/560	56
XDV 38/570	57
XDV 38/580	58
XDV 38/590	59
XDV 38/600	60
XDV 38/610	61
XDV 38/620	62
XDV 38/630	63
XDV 38/690	69
XDV 38/710	71
XDV 38/740	74
XDV 38/750	75

SECTION XDV2-48	
Code	External length LE (inches)
XDV 48/170	17
XDV 48/180	18
XDV 48/190	19
XDV 48/200	20
XDV 48/210	21
XDV 48/220	22
XDV 48/230	23
XDV 48/240	24
XDV 48/250	25
XDV 48/260	26
XDV 48/270	27
XDV 48/280	28
XDV 48/290	29
XDV 48/300	30
XDV 48/310	31
XDV 48/320	32
XDV 48/330	33
XDV 48/340	34
XDV 48/350	35
XDV 48/360	36
XDV 48/370	37
XDV 48/380	38
XDV 48/390	39
XDV 48/400	40
XDV 48/410	41
XDV 48/420	42
XDV 48/430	43
XDV 48/440	44
XDV 48/450	45
XDV 48/460	46
XDV 48/470	47
XDV 48/480	48
XDV 48/490	49
XDV 48/500	50
XDV 48/510	51
XDV 48/520	52
XDV 48/530	53
XDV 48/540	54
XDV 48/550	55
XDV 48/560	56
XDV 48/570	57
XDV 48/580	58
XDV 48/590	59
XDV 48/600	60
XDV 48/610	61
XDV 48/620	62
XDV 48/630	63
XDV 48/640	64
XDV 48/650	65
XDV 48/660	66
XDV 48/670	67
XDV 48/680	68
XDV 48/690	69
XDV 48/700	70
XDV 48/710	71
XDV 48/720	72
XDV 48/730	73
XDV 48/740	74
XDV 48/750	75
XDV 48/760	76
XDV 48/770	77
XDV 48/780	78
XDV 48/790	79
XDV 48/800	80
XDV 48/810	81
XDV 48/820	82
XDV 48/830	83
XDV 48/840	84
XDV 48/850	85
XDV 48/860	86
XDV 48/870	87
XDV 48/880	88
XDV 48/890	89
XDV 48/900	90
XDV 48/910	91
XDV 48/920	92
XDV 48/930	93
XDV 48/940	94
XDV 48/950	95
XDV 48/960	96
XDV 48/970	97
XDV 48/980	98
XDV 48/990	99
XDV 48/1000	100
XDV 48/1050	105
XDV 48/1070	107
XDV 48/1140	114
XDV 48/1170	117

SECTION XDV2-58	
Code	External length LE (inches)
XDV 58/230	23
XDV 58/240	24
XDV 58/250	25
XDV 58/260	26
XDV 58/270	27
XDV 58/280	28
XDV 58/290	29
XDV 58/300	30
XDV 58/310	31
XDV 58/320	32
XDV 58/330	33
XDV 58/340	34
XDV 58/350	35
XDV 58/360	36
XDV 58/370	37
XDV 58/380	38
XDV 58/390	39
XDV 58/400	40
XDV 58/410	41
XDV 58/420	42
XDV 58/430	43
XDV 58/440	44
XDV 58/450	45
XDV 58/460	46
XDV 58/470	47
XDV 58/480	48
XDV 58/490	49
XDV 58/500	50
XDV 58/510	51
XDV 58/520	52
XDV 58/530	53
XDV 58/540	54
XDV 58/550	55
XDV 58/560	56
XDV 58/570	57
XDV 58/580	58
XDV 58/590	59
XDV 58/600	60
XDV 58/610	61
XDV 58/620	62
XDV 58/630	63
XDV 58/640	64
XDV 58/650	65
XDV 58/660	66
XDV 58/670	67
XDV 58/680	68
XDV 58/690	69
XDV 58/700	70
XDV 58/710	71
XDV 58/720	72
XDV 58/730	73
XDV 58/740	74
XDV 58/750	75
XDV 58/760	76
XDV 58/770	77
XDV 58/780	78
XDV 58/790	79
XDV 58/800	80
XDV 58/810	81
XDV 58/820	82
XDV 58/830	83
XDV 58/840	84
XDV 58/850	85
XDV 58/860	86
XDV 58/870	87
XDV 58/880	88
XDV 58/890	89
XDV 58/900	90
XDV 58/910	91
XDV 58/920	92
XDV 58/930	93
XDV 58/940	94
XDV 58/950	95
XDV 58/960	96
XDV 58/970	97
XDV 58/980	98
XDV 58/990	99
XDV 58/1000	100
XDV 58/1030	103
XDV 58/1080	108

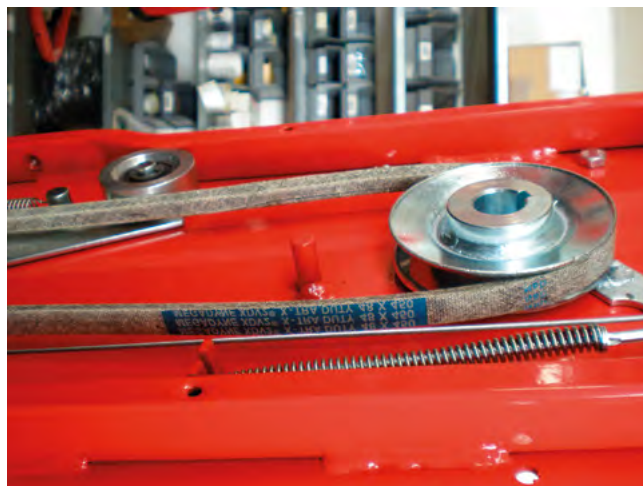

LINEA GOLD - LINEA-X - VARISECT
Rubber raw edge V-Belts

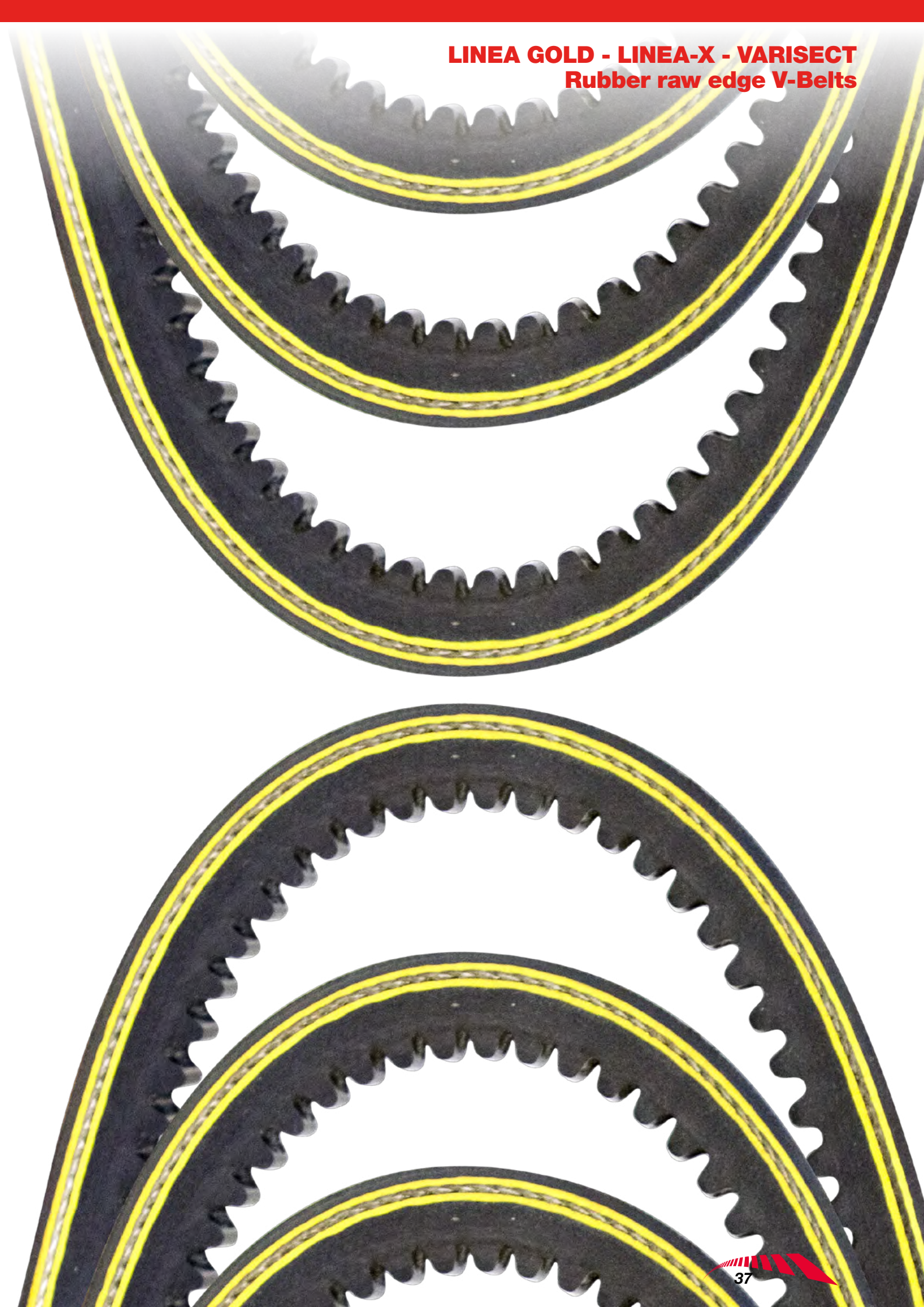

LINEA-X - LINEA GOLD - VARISECT

Rubber raw edge V-Belts

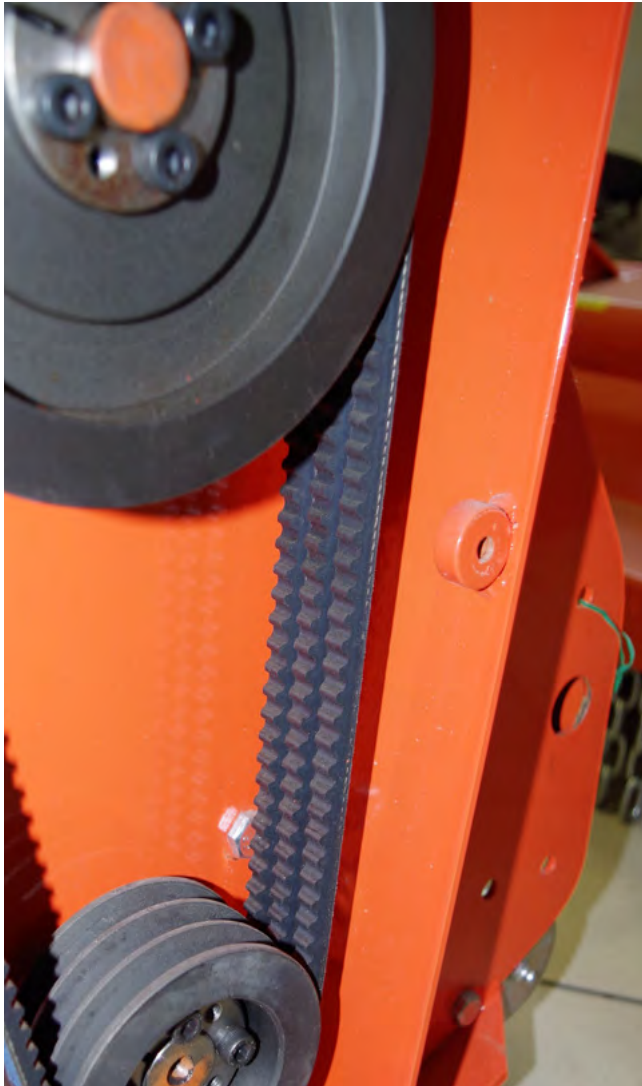

LINEA-X

These belts have been specifically developed to run where small pulley diameters and high transmission ratios put a limit to the use of wrapped belts of the same section. Compared to wrapped belts, LINEA-X family has important improvements, like specific compounds and special production technology. In particular the transverse orientation of the fibers improves the cord support capacity of the body section and reinforces its transverse rigidity, while maintaining, (due to the cogged profile and the precision-ground sidewalls) the highest longitudinal flexibility and running stability. These characteristics guarantee an excellent structure with advantages such as: high transmission ratios, improved grip and resistance to continuous bending.

LINEA GOLD

The NEW generation of raw edge belts. New materials, advanced design features and an innovative production process has led MEGADYNE to develop a new generation of raw edge V-belt drives that outperform, in a wide range of industrial applications, all the previous drives equipped with standard raw edge belts, granting large cost advantages for the end users and greater design flexibility for the engineers. The belt has a narrow cross section and a raw edge construction, based on a new EPDM rubber compound which can withstand chemically aggressive environments, ageing, ozone, UV and heat.

Special constructions and laminated belts are available on request.

MEGAMATCH MEGA MATCH

All Linea Gold and Linea-X V-belts carrying the MEGA MATCH logo are made and supplied according to the matching set tolerances and limits indicated by the relevant international standards (ISO, RMA, etc)

VARISECT

It means Variable Speed V-Belt. Designed for variable speed transmissions, to obtain a wide range of driven speeds, VARISECT resists fatigue and shock, providing excellent belt stability



LINEA GOLD Rubber raw edge V-Belts

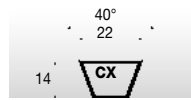
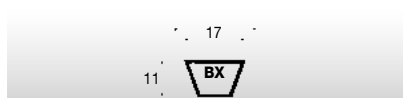
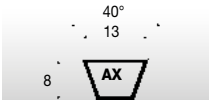

SECTION AX	
Code	External length LE (mm)
AX 21	585
AX 22	610
AX 23	635
AX 24	665
AX 25	690
AX 26	710
AX 27	750
AX 28	765
AX 29	800
AX 30	815
AX 31	850
AX 32	865
AX 33	900
AX 34	915
AX 35	950
AX 36	965
AX 37	1000
AX 38	1020
AX 39	1045
AX 40	1075
AX 41	1095
AX 42	1120
AX 43	1150
AX 44	1170
AX 45	1195
AX 46	1230
AX 47	1245
AX 48	1270
AX 49	1300
AX 50	1325
AX 51	1350
AX 52	1375
AX 53	1400
AX 54	1425
AX 55	1450
AX 56	1475
AX 57	1500
AX 58	1525
AX 59	1550
AX 60	1585
AX 61	1600
AX 62	1630
AX 63	1655
AX 64	1680
AX 65	1710
AX 66	1730
AX 67	1760
AX 68	1790
AX 69	1810
AX 70	1830
AX 71	1865
AX 72	1890
AX 73	1905
AX 74	1935
AX 75	1965
AX 76	1985
AX 77	2010
AX 78	2030
AX 79	2060
AX 80	2080
AX 81	2120
AX 82	2140
AX 83	2160
AX 84	2190
AX 85	2220
AX 86	2240
AX 87	2260
AX 88	2290
AX 89	2310
AX 90	2350
AX 91	2360
AX 92	2390
AX 93	2420
AX 94	2440
AX 95	2470
AX 96	2500
AX 97	2520
AX 98	2540
AX 100	2600
AX 103	2670
AX 105	2730
AX 110	2850
AX 112	2910
AX 120	3110
AX 128	3310
AX 136	3510
AX 144	3710
AX 158	4070
AX 173	4450
AX 180	4620

SECTION BX	
Code	External length LE (mm)
BX 28	785
BX 32	885
BX 34	935
BX 35	960
BX 36	990
BX 38	1040
BX 40	1090
BX 41	1120
BX 42	1140
BX 43	1165
BX 44	1190
BX 45	1215
BX 46	1250
BX 47	1265
BX 48	1295
BX 49	1320
BX 50	1345
BX 51	1370
BX 52	1400
BX 53	1420
BX 54	1445
BX 55	1470
BX 56	1500
BX 57	1520
BX 58	1545
BX 59	1570
BX 60	1600
BX 61	1625
BX 62	1650
BX 63	1675
BX 64	1700
BX 65	1725
BX 66	1750
BX 67	1775
BX 68	1800
BX 69	1825
BX 70	1850
BX 71	1875
BX 72	1900
BX 73	1930
BX 74	1955
BX 75	1980
BX 76	2000
BX 77	2030
BX 78	2050
BX 79	2080
BX 80	2110

SECTION BX	
Code	External length LE (mm)
BX 81	2130
BX 82	2160
BX 83	2180
BX 84	2210
BX 85	2240
BX 86	2260
BX 87	2280
BX 88	2310
BX 89	2330
BX 90	2360
BX 91	2390
BX 92	2410
BX 93	2440
BX 94	2460
BX 95	2500
BX 96	2510
BX 97	2540
BX 98	2560
BX 99	2590
BX 100	2620
BX 103	2690
BX 105	2740
BX 106	2770
BX 108	2820
BX 112	2920
BX 113	2940
BX 115	2990
BX 116	3020
BX 120	3130
BX 123	3200
BX 124	3220
BX 126	3270
BX 128	3330
BX 133	3450
BX 136	3530
BX 140	3630
BX 144	3740
BX 148	3830
BX 150	3880
BX 154	3990
BX 158	4090
BX 162	4200
BX 173	4480
BX 180	4650
BX 191	4930
BX 195	5040

SECTION CX	
Code	External length LE (mm)
CX 51	1400
CX 55	1500
CX 60	1630
CX 68	1830
CX 72	1935
CX 75	2000
CX 78	2090
CX 81	2160
CX 85	2270
CX 90	2390
CX 96	2540
CX 100	2650
CX 101	2670
CX 105	2770
CX 109	2870
CX 111	2920
CX 112	2950
CX 115	3030
CX 120	3150
CX 128	3350
CX 136	3550
CX 144	3760
CX 148	3860
CX 150	3920
CX 158	4120
CX 162	4220
CX 173	4500
CX 180	4680

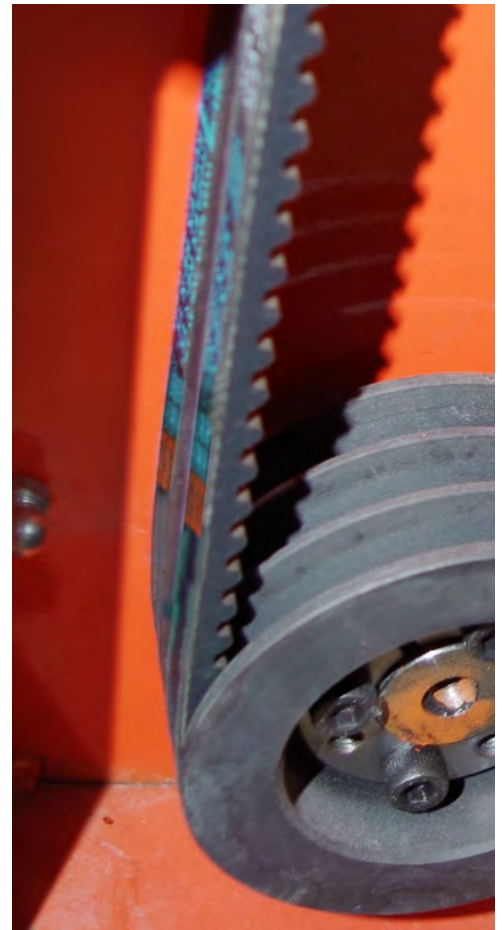

VARISECT Rubber variable speed belts

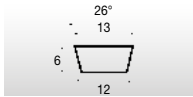

SECTION 13x6	
Code	Nominal pitch length LD (mm)
425	425
500	500
525	525
555	555
650	650
675	675
700	700
725	725
750	750
775	775
900	900

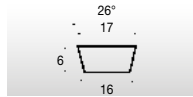

SECTION 17x6 W16	
Code	Nominal pitch length LD (mm)
W 16P	450
W 16P	500
W 16P	560
W 16P	600
W 16P	630
W 16P	710
W 16P	800
W 16P	900
W 16P	1000

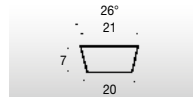

SECTION 21x7 W20	
Code	Nominal pitch length LD (mm)
W 20P	560
W 20P	630
W 20P	640
W 20P	710
W 20P	800
W 20P	900
W 20P	1000
W 20P	1120
W 20P	1250

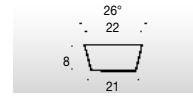

SECTION 22x8	
Code	Nominal pitch length LD (mm)
500	500
525	525
550	550
575	575
600	600
610	610
625	625
650	650
675	675
700	700
725	725
750	750
800	800
850	850
900	900
950	950
1000	1000
1060	1060
1120	1120
1180	1180
1250	1250
1320	1320
1400	1400
1500	1500
1600	1600
2000	2000

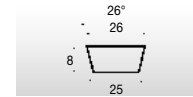

SECTION 26x8 W25	
Code	Nominal pitch length LD (mm)
W 25P	560
W 25P	690
W 25P	710
W 25P	750
W 25P	790
W 25P	800
W 25P	900
W 25P	1000
W 25P	1120
W 25P	1250
W 25P	1400
W 25P	1613

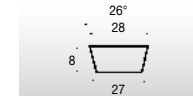

SECTION 28x8	
Code	Nominal pitch length LD (mm)
525	525
600	600
625	625
650	650
700	700
750	750
800	800
850	850
900	900
950	950
1000	1000
1060	1060
1120	1120
1180	1180
1250	1250
1320	1320
1400	1400
1500	1500
1600	1600
1700	1700

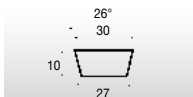

SECTION 30x10	
Code	Nominal pitch length LD (mm)
650	650
665	665
700	700
800	800
850	850
875	875
900	900
950	950
1000	1000
1035	1035
1050	1050
1120	1120
1200	1200
1320	1320
1340	1340
1500	1500
1600	1600

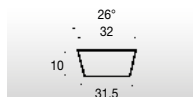

SECTION 32x10 W31,5	
Code	Nominal pitch length LD (mm)
W 31,5P	800
W 31,5P	840
W 31,5P	870
W 31,5P	900
W 31,5P	950
W 31,5P	1000
W 31,5P	1050
W 31,5P	1120
W 31,5P	1250
W 31,5P	1400
W 31,5P	1600
W 31,5P	1800
W 31,5P	2000

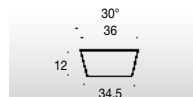

SECTION 36x12	
Code	Nominal pitch length LD (mm)
700	700
725	725
800	800
850	850
900	900
950	950
1000	1000
1060	1060
1120	1120
1180	1180
1250	1250
1320	1320
1400	1400
1500	1500
1600	1600
1700	1700
1800	1800
2000	2000
2120	2120

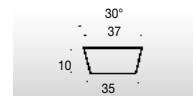

SECTION 37x10	
Code	Nominal pitch length LD (mm)
600	600
650	650
675	675
750	750
800	800
850	850
900	900
950	950
1000	1000
1060	1060
1120	1120
1180	1180
1250	1250
1320	1320
1400	1400
1500	1500
1600	1600
1700	1700
1800	1800
1900	1900
2000	2000
2240	2240

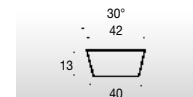

SECTION 42x13 W40	
Code	Nominal pitch length LD (mm)
W 40P	1060
W 40P	1100
W 40P	1120
W 40P	1180
W 40P	1250
W 40P	1400
W 40P	1600
W 40P	1660
W 40P	1820
W 40P	2000
W 40P	2240
W 40P	2500

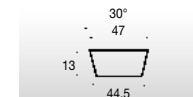

SECTION 47x13	
Code	Nominal pitch length LD (mm)
900	900
950	950
1000	1000
1060	1060
1120	1120
1180	1180
1250	1250
1320	1320
1400	1400
1500	1500
1600	1600
1700	1700
1800	1800
1900	1900
2000	2000
2240	2240

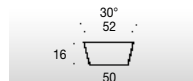

SECTION 52x16 W50	
Code	Nominal pitch length LD (mm)
W 50P	1250
W 50P	1400
W 50P	1600
W 50P	1800
W 50P	2000
W 50P	2240
W 50P	2500
W 50P	2800
W 50P	3150

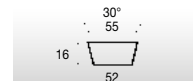

SECTION 55x16	
Code	Nominal pitch length LD (mm)
1180	1180
1250	1250
1400	1400
1600	1600
1700	1700
1800	1800
2000	2000
2240	2240

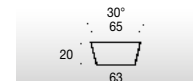

SECTION 65x20 W63	
Code	Nominal pitch length LD (mm)
W 63P	1600
W 63P	1800
W 63P	2000
W 63P	2240
W 63P	2500
W 63P	2800
W 63P	3150
W 63P	3550
W 63P	4000

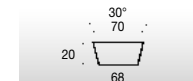

SECTION 70x20	
Code	Nominal pitch length LD (mm)
1320	1320
1400	1400
1445	1445
1500	1500
1600	1600
1700	1700
1800	1800
1900	1900
2000	2000
2120	2120
2240	2240
2360	2360
2500	2500
2800	2800

ACCU-LINK

Urethane adjustable V-Belts

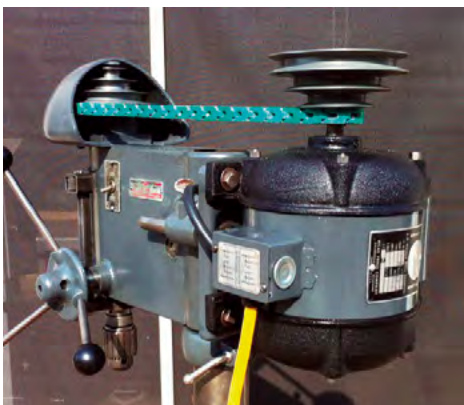
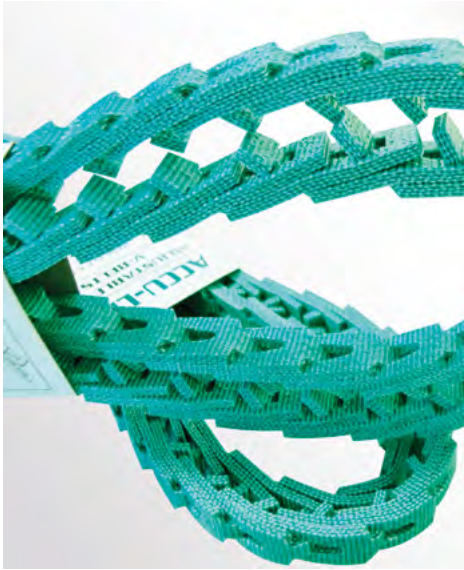

ACCU_LINK adjustable V-Belts are the ideal replacement substitute for conventional rubber V-Belts.

Solve V-Belt drive problems quickly, accurately & permanently, the ideal temporary replacement or permanent substitute for conventional rubber V-Belts, **ACCU-LINK** V-Belts combine superior strength, durability and quick, easy assembly to keep equipment up and running at the same running horse power ratings as rubber belts.

Constructed of urethane elastomer reinforced with a rugged, woven polyester fabric, **ACCU-LINK** V-belts are manufactured by a revolutionary new process which creates smooth, precise side profiles on each link. This smooth profile creates less vibration and requires lower drive tensions for increased belt life. Designed to any drive application, **ACCU-LINK** V-belts are available in the most popular sizes: Z/3L A/4L, B/5L, and C sections in roll and sleeve. What's more, **ACCU-LINK** V-belts maintain precise tension, so they deliver maximum power on multiple-belt drives.

- Durable urethane coating Precision machined sides for smooth engagement
- Rugged, woven polyester fabric for strength and longer belt life.
- **ACCU-LINK** cross section ideal for diverse operating environments
- **ACCU-LINK** V-belt urethane construction offers superior resistance to most common industrial solvents and chemicals, oil, water and extreme temperatures, from -25°C to 80°C.
- **ACCU-LINK** V-belts dissipate heat so they run cooler than conventional belts.

Installation is a snap installation and assembly is as easy as a snap and a twist.

No special tools are required to couple or uncouple each **ACCU-LINK** V-Belt.

Belts can be made to accommodate any length, which makes them ideal for emergency repairs and replacements. Once assembled, **ACCU-LINK** V-Belts are installed in a fraction of the time needed for endless rubber belts. AccuLink V-Belts are installed in minutes without removing outboard bearings or moving motors.

Suited to harsh environments, **ACCU-LINK** V-belts are ideal for the metal processing, machine tool, agricultural, packaging, coal and aggregate, pulp and paper, lumber, marine, air moving, petrochemical, woodworking, conveying and food industries, HVAC.

Choose **ACCU-LINK** For:

- Durability
- Easy Assembly
- Fast Installation
- Maximum Horsepower
- Dependability

	RANGE			
	Z/3L	A/4L	B/5L	C
5' SLEEVE	X	X		X
6' SLEEVE		X	X	
25' ROLL	X	X	X	X
50' ROLL				X
100' ROLL	X	X	X	

MULTI-RIB BELTS

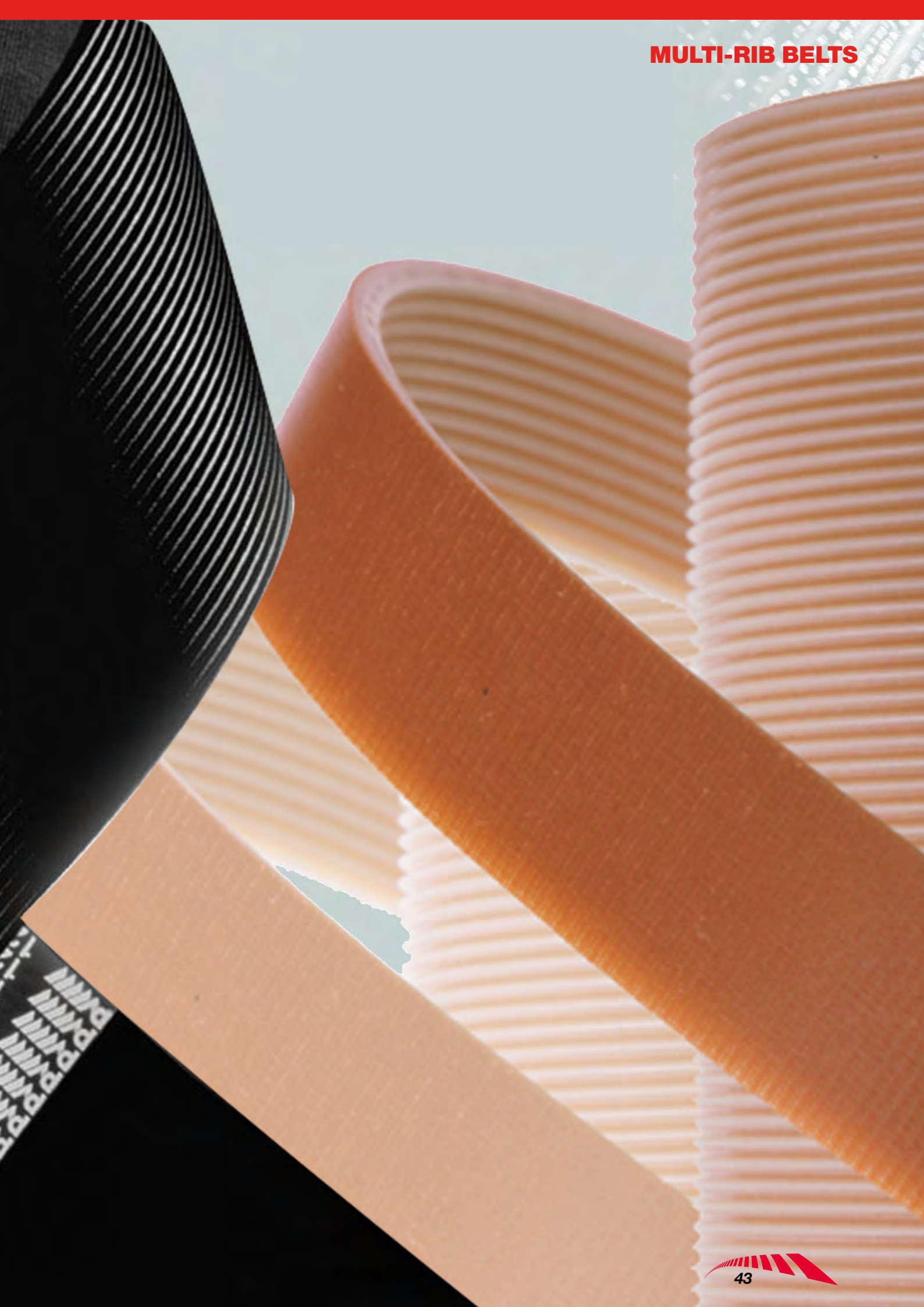

PHOTO: J. L. BROWN

PV Rubber ribbed belts



PV RIBBED BELTS are made of polybutadiene compound. High performance V ribbed belts are produced in **PH, PJ, PK, PL** and **PM** profiles.

PV belts design:

- eliminates belt matching;
- permits drive design to meet exact power or space requirements;
- distributes the drive load across the entire belt width;
- permits cooler running and high drive efficiency;
- excels on small pulleys at high speeds.

PV-Ribbed belts are also available in elastic version (TEM) and they are suitable in the transmission where fixed centre distance is required. The TEM belt is developed according to the Customer requirements.

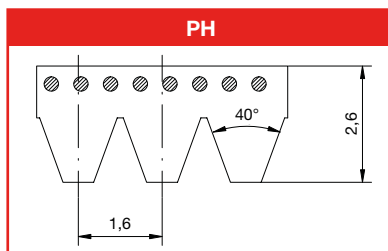
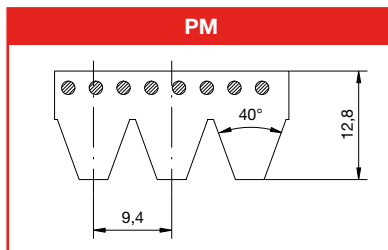
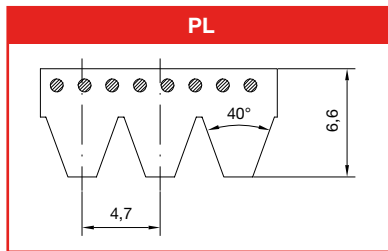
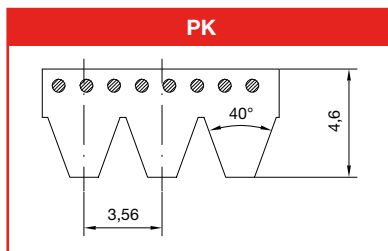
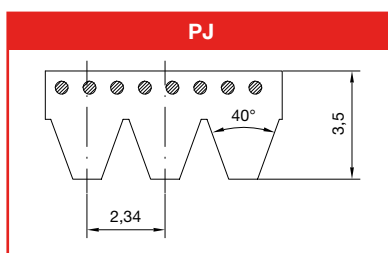

PJ		PJ		PK		PL		PM	
Effective length (mm)	(inches)	Effective length (mm)	(inches)	Effective length (mm)	(inches)	Effective length (mm)	(inches)	Effective length (mm)	(inches)
350	13.8	1270	50.0	588	23,1	953	37,5	2286	90,0
381	15.0	1280	50.4	630	24.8	991	39,0	2388	94,0
406	16.0	1287	50.7	650	25.6	1041	41,0	2515	99,0
432	17.0	1295	51.0	675	26.6	1074	42,3	2693	106,0
457	18.0	1301	51.0	700	27.6	1080	42,5	2832	111,5
483	19.0	1302	51.3	730	28.7	1100	43,3	2921	115,0
495	19.5	1315	51.8	755	29.7	1150	45,3	3010	118,5
508	20.0	1318	51.9	775	30.5	1168	46,0	3124	123,0
533	21.0	1321	52.0	800	31.5	1194	47,0	3327	131,0
559	22.0	1326	52.2	830	32.7	1219	48,0	3531	139,0
584	23.0	1365	53.7	845	33.3	1270	50,0	3734	147,0
610	24.0	1371	54.0	870	34.3	1295	51,0	4089	161,0
635	25.0	1397	55.0	875	34.4	1321	52,0	4191	165,0
650	25.6	1428	56.2	885	34.8	1334	52,5	4470	176,0
660	26.0	1473	58.0	920	36.2	1372	54,0	4648	183,0
685	27.0	1524	60.0	925	36.4	1397	55,0	5029	198,0
711	28.0	1549	61.0	950	37.4	1422	56,0	5410	213,0
723	28.5	1600	63.0	970	38.2	1435	56,5	6121	241,0
737	29.0	1651	65.0	1000	39.4	1473	58,0	6883	271,0
762	30.0	1752	69.0	1015	40.0	1498	59,0	7646	301,0
769	30.3	1854	73.0	1035	40.8	1511	59,5	8408	331,0
790	31.1	1895	74.6	1060	41.7	1562	61,5	9169	361,0
813	32.0	1910	75.2	1080	42.5	1613	63,5	9931	391,0
864	34.0	1930	76.0	1145	45.1	1651	65,0	10693	421,0
895	35.2	1956	77.0	1165	45.9	1664	65,5	12217	481,0
914	36.0	2083	82.0	1200	47.2	1715	67,5	13741	541,0
944	37.2	2135	84.1	1230	48.4	1765	69,5	15266	601,0
955	37.6	2210	87.0	1300	51.2	1803	71,0	16764	660,0
965	38.0	2337	92.0	1335	52.6	1842	72,5		
990	39.0	2489	98.0	1385	54.5	1943	76,5		
1016	40.0			1420	55.9	1956	77,0		
1036	40.8			1460	57.5	1981	78,0		
1040	40.9			1490	58.7	2019	79,5		
1051	41.4			1520	59.8	2070	81,5		
1065	41.9			1555	61.2	2096	82,5		
1080	42.5			1610	63.4	2134	84,0		
1089	42.9			1655	65.2	2197	86,5		
1092	43.0			1700	66.9	2235	88,0		
1100	43.3			1725	67.9	2324	91,5		
1108	43.6			1755	69.1	2362	93,0		
1116	43.9			1800	70.9	2477	97,5		
1136	44.7			1860	73.2	2515	99,0		
1143	45.0			1885	74.2	2705	106,5		
1150	45.3			1900	74.8	2743	108,0		
1160	45.7			1980	78.0	2845	112,0		
1168	46.0			2050	80.7	2896	114,0		
1170	46.1			2080	81.9	2921	115,0		
1184	46.6			2145	84.5	2997	118,0		
1190	46.9			2235	88.0	3086	121,5		
1194	47.0			2330	91.7	3124	123,0		
1200	47.2			2490	98.03	3289	129,5		
1203	47.4					3327	131,0		
1210	47.6					3493	137,0		
1214	47.8					3696	145,5		
1222	48.1					4051	159,5		
1232	48.5					4191	165,0		
1236	48.7					4470	176,0		
1244	49.0					4623	182,0		
1262	49.7					5029	198,0		

PH	
Effective length (mm)	(inches)
584	23.0
947	37.3
1025	40.4
1030	40.6
1068	42.0
1140	44.9
1164	45.8
1200	47.2
1210	47.6
1265	49.8
1809	71.2
1831	72.1
1856	73.1
1872	73.7
1891	74.4
1900	74.8
1915	75.4
1922	75.7
1930	76.0
1945	76.6
1975	77.8

MEGARIB PU endless ribbed belts



MEGARIB belts are manufactured in polyurethane with polyester high tension cords, which combine the high flexibility of flat belts with the power transmission capability of v-belts.

MEGARIB features

- Dimensional stability
- High flexibility
- Small pulley diameters
- High speeds
- Excellent oil, water and ozone resistance

The main applications are

- Food processors
- Grass cutting equipment
- Electrical household appliances
- Washing machines
- Electrical tools
- Woodworking equipment
- Domestic power tools



On request, special elastic Megarib belts can be manufactured in polyurethane with a semi-elastic tension member. They can be fitted on fix centre drives, reducing noise and vibrations. The absence of a tensioning mechanism, offers additional cost savings.

Standard Megarib belts are available in a wide variety of rib pitches and length (see below).

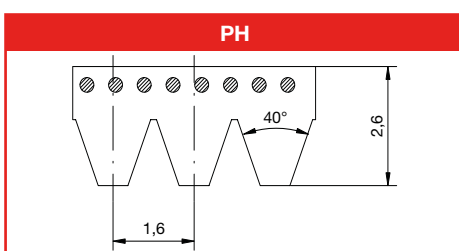
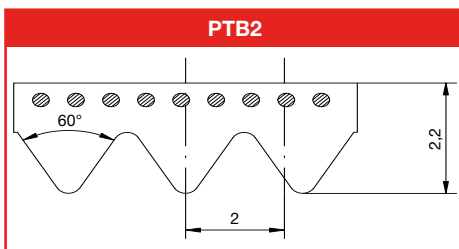
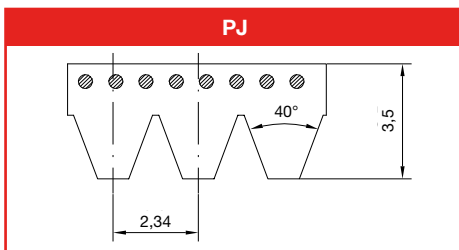

PJ	
Standard length (mm)	(inches)
220	8,7
271	10,7
275	10,8
278	10,9
283	11,1
288	11,3
304	12,0
317,5	12,5
330	13,0
345	13,6
356	14,0
381	15,0
392	15,4
406	16,0
431	17,0
444	17,5
457	18,0
483	19,0
508	20,0
558	22,0
584	23,0
610	24,0
630	24,8
660	26,0
681	26,8
711	28,0
762	30,0
864	34,0
914	36,0
953	37,5
1010	39,8
1086	42,8
1120	44,1
1163	45,8
1202	47,3
1239	48,8
1268	49,9
1397	55,0

PTB2	
Standard length (mm)	(inches)
156	6,1
170	6,7
200	7,9
220	8,7
231	9,1
248	9,8
266	10,5
295	11,6
310	12,2
330	13,0
345	13,6
360	14,2
380	15,0
390	15,4
400	15,7
430	16,9
480	18,9
510	20,1
526	20,7
535	21,1
575	22,6
598	23,5
630	24,8
660	26,0
675	26,6
725	28,5
770	30,3
1186	46,7

PH	
Standard length (mm)	(inches)
223	8,8
261	10,3
269	10,6
295	11,6
330	13,0
340	13,4
345	13,6
375	14,8
389	15,3
507	19,9
588	23,1
609	24,0
650	25,6
768	30,2
935	36,8
1000	39,4
1086	42,8
1120	44,1
1163	45,8
1203	47,4
1240	48,8
1775	69,9

SPECIAL & FABRICATED BELTS
Megaweld, Covers, Cleats,
False Teeth, PPJ System, Special Modifications



MEGAWELD Thermoweldable belts

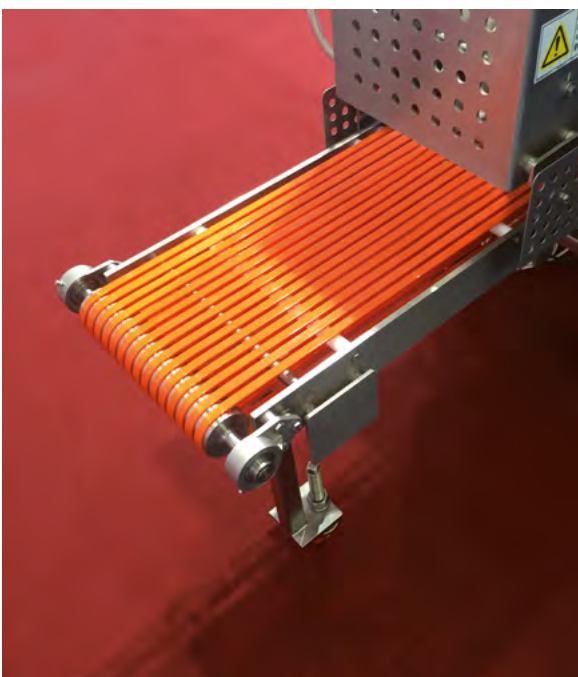
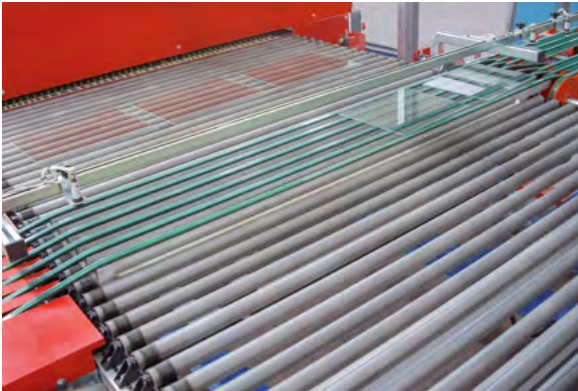
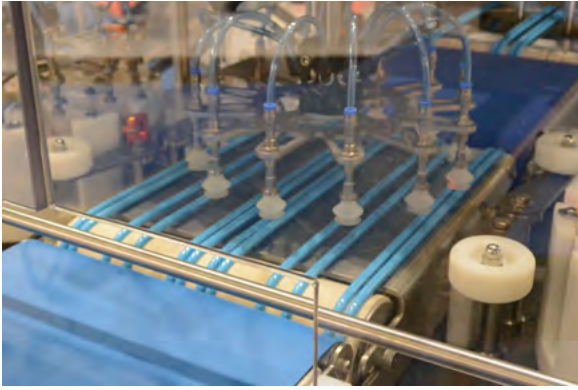

MEGAWELD thermoplastic polyurethane, trapezoidal and round belts are manufactured by a unique extrusion process. They are suitable for a wide range of applications and industries.

MEGAWELD are used for conveying or for light power transmission in the following areas:

- ceramic industry
- glass industry
- wood industry
- brick and tile industry
- gardening and horticulture
- packagin industry
- paper and board industry
- pharmaceutical industry
- food industry
- robotic systems
- automotive



V-belts		
Code	Hardness	Section
PT85 / PTD85	85 ShA	Z / A / B / C / D
PT85RK / PTD85RK	85 ShA	Z / A / B / C / D
PT90 / PTD90	90 ShA	Z / A / B / C / D
PT90RK / PTD90RK	90 ShA	Z / A / B / C / D
PT100 / PTD100	100 ShA – 55 ShD	Z / A / B / C



Round belt		
Code	Hardness	Section
PR85	85 ShA	Ø 3 :- 18 mm
PR85NL	85 ShA	Ø 2 :- 15 mm
PR85RK	85 ShA	Ø 6 :- 18 mm
PR90	90 ShA	Ø 2 :- 18 mm

COVERS

Megadyne offers a variety of coverings in Polyurethane, elastomer, foam, PVC and other unique solutions. See below some examples. Choose the covering that interests you or request for more information to our OEM team, we will suggest the right solution.

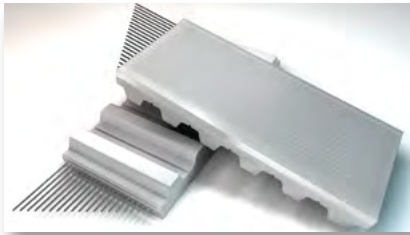

AVAFC 60/70/85 Sha - Cover is used for conveying abrasive materials, with high friction especially on smooth and dry surfaces, with good (60 & 70 ShA) to very good (85 ShA) abrasion resistance.

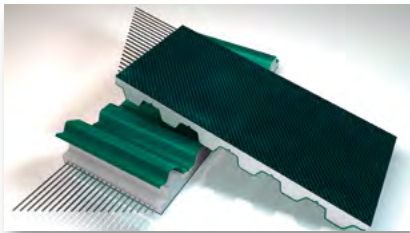

NFT/NFB NYLON FABRIC (TEETH AND BACK) - NFT/NFB offers low friction for accumulation as well as low noise benefits and is usually applied by Co-extrusion on base belts. Antistatic version in black color available.

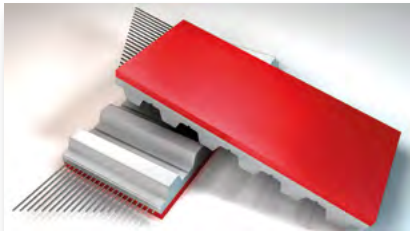

APL - Seamless Cover used as an alternative to Natural Rubber offering a high friction and good resistance to oil and water.

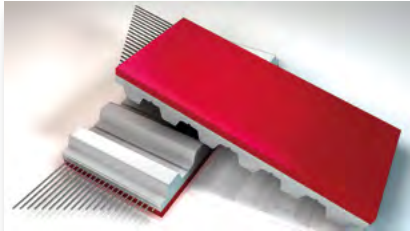

RED GRIP - Seamless Cover used as an alternative to Natural Rubber offering a high friction and a very good oil and abrasion resistance. Only available on Megaflex.

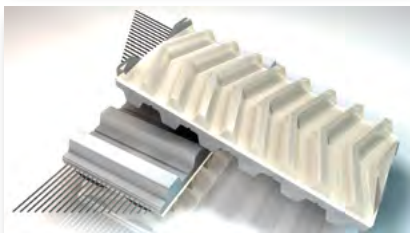

PU FISHBONE - Cover suitable for wet environments as in the glass industry where friction and drainage are necessary. Very good water and abrasion resistance.

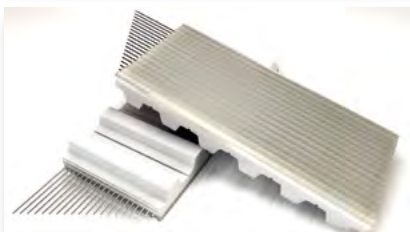

PU RIBBED - Cover with reduced contact points for conveying sensitive products in material handling applications with very good water and abrasion resistance. Allows drain of liquids.

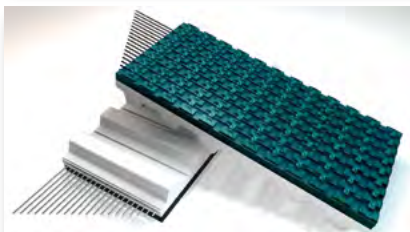

SUPERGRIP PETROL - PVC Cover with high CoF, applicable for slight height compensation, low shock absorption capabilities. Improved adhesion even in case of moisture and dirt - for incline, feed and take-a-way conveying applications. Seamless weldable on Megalinear and Megaflex.

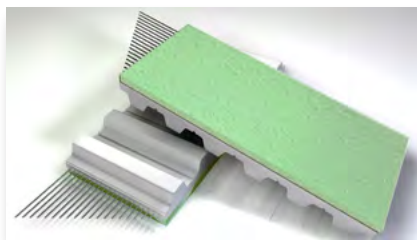

SYLOMER BLUE, GREEN, BROWN - Cover with low density offers high dynamic load capacity for light and sensitive parts up to top pressure belts and glass moving applications with a good water resistance.

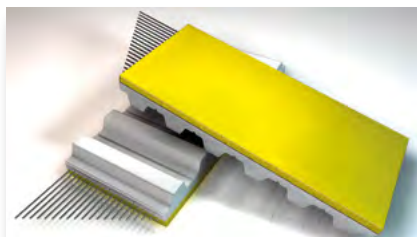

PU YELLOW - Sprayed endless, available in different hardness and colours Widely-used foam with very good abrasion resistance. Used in paper and glass industry. Due to easy mechanical processing very popular for vacuum transport application.

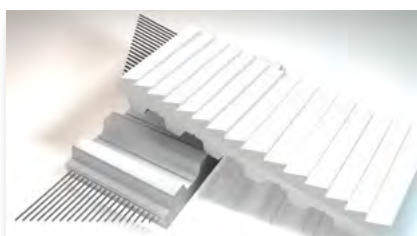

PVC SAW TOOTH - FDA clear pattern for improved adhesion under wet conditions Line contact, resistant against acids and bases.

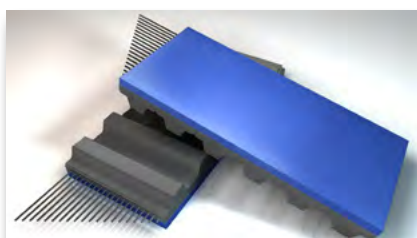

BLUE GRIP - NR/BR Cover 57 ShA with a improved abrasion resistance and a high friction. Universally applicable as alternative to Natural Rubber. Only available on rubber base belts.

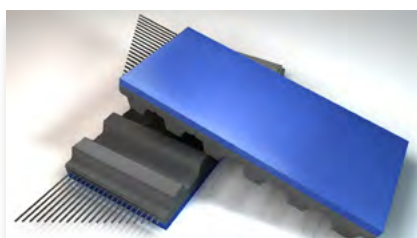

HTX - SILBLUE - Cover offers high temperature and UV resistance. Non-marking compound common used in printing applications. Only available on rubber base belts.

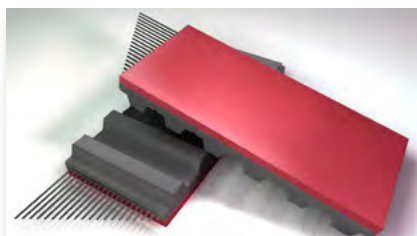

RED NATURAL RUBBER 40 - Cover offers low durometer ShA and very good high friction; applicable on any kind of conveyor or feeding application.

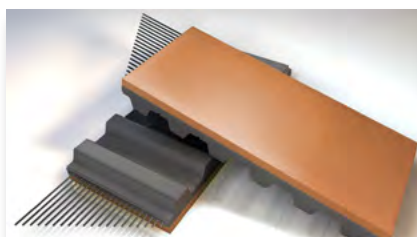

DURATAQ® - Natural Premium Rubber Cover with specific designed compound to reach a very good abrasion resistance with a very high coefficient of friction. Successfully installed in medium and heavy load conveyance as cable puller applications.

CLEATS

Megadyne timing belts can be customised by vulcanizing profiles vulcanized on their back. All the cleats are made using thermoplastic polyurethane. The cleats are attached using high frequency vibration welding. The production process for these profiles is very flexible; Megadyne can design any profile to meet the specific customer requirement.

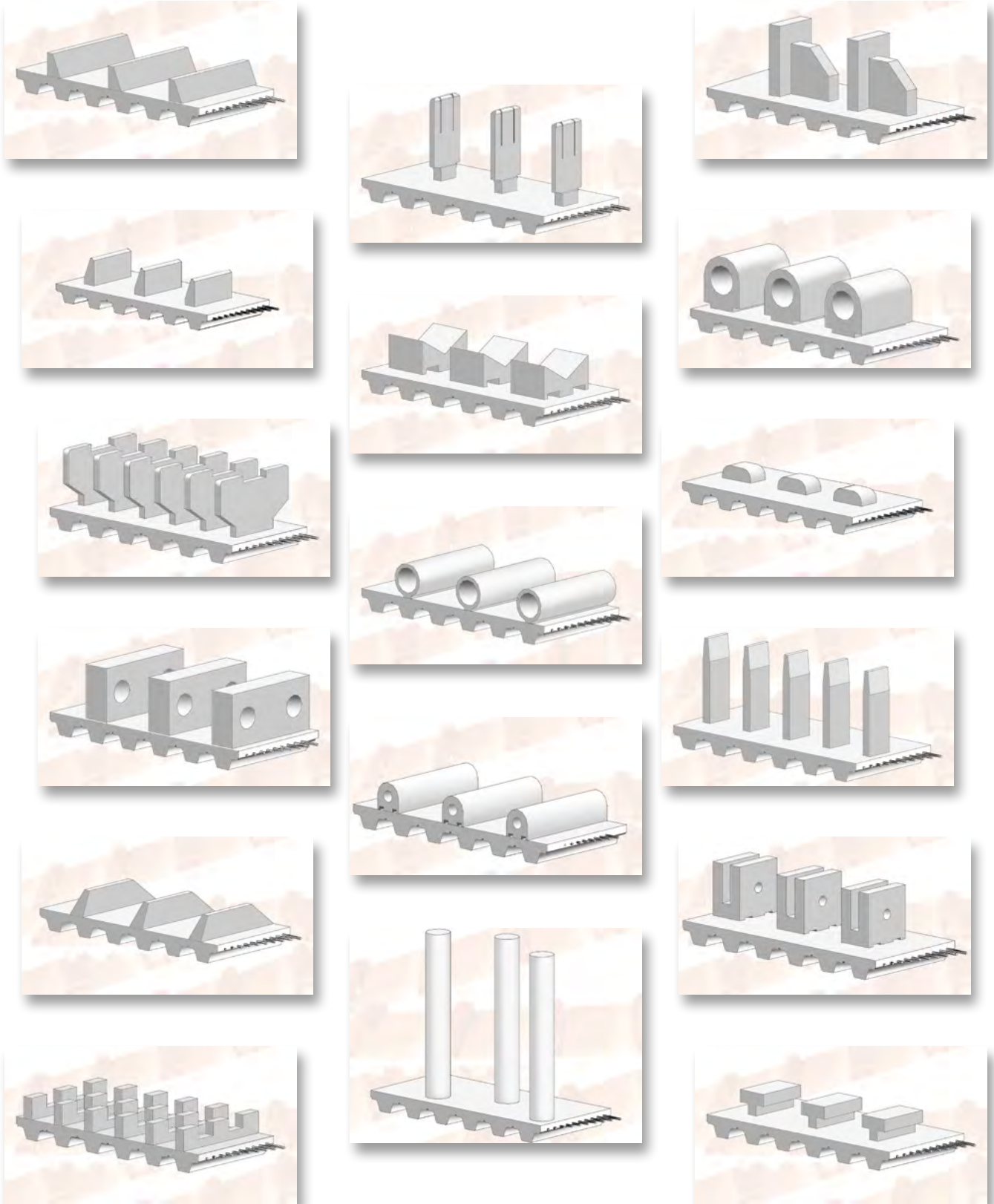

Megadyne has developed a new solution of mechanical profile application system specially designed for attaching cleats that cannot be welded onto polyurethane timing belts: FALSE TOOTH SYSTEM (FTS).

This mechanical mounting system for timing belts allows quick and easy exchange of individually designed cleats of different material (steel, urethane, UHMW, plastic, wood).

Now it is available a wide range of metallic false teeth with highly versatile and innovative system for attaching cleats in various positions, allowing synchronized feeding and product handling.

The belt can run smoothly around pulleys because the threaded inserts are embedded within the milled teeth.

FTS ADVANTAGES INCLUDE:

- Easy exchange at any time.
- Can transmit much higher loads than welded profiles.
- Low cost in spare part in case of wear and tear.
- Reduction cost in assembly.
- Easy cleats fixing operation.
- Different cleat's material can be used.
- False tooth in stainless steel suitable for food & pharmaceutical industry.
- Not need to remove the belt in case of cleats replacement.
- High precision on profile positioning.
- Available on MEGALINEAR JOINED, MEGAFLEX and MEGAPOWER in all possible executions as NFT or NFB, FDA, steel, aramid or stainless steel cord, with or without self-tracking guide.



PPJ SYSTEM

Technical features

- Reduced load capacity when compared to standard joined belts
- Created to allow the jointing of belts directly on the machine
- Allows a very fast belt replacement
- The back of the belts is virtually flat
- Born for conveying applications only, max suggested speed is 120 m/min
- Pin materials according to AISI302
- Rolls with NFT, NFB, AVAFC, APL, Fishbone, Ribbed and Supergrip can be PPJed
- Minimum splice length of 700 mm

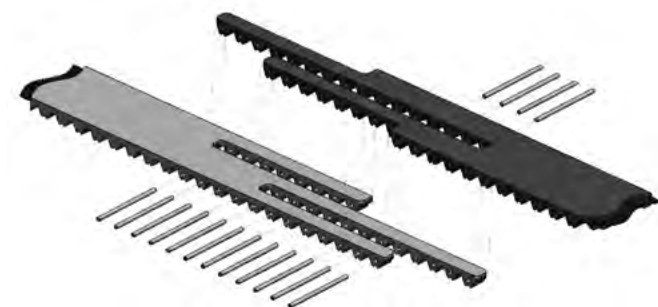

STOP to maintenance shutdowns

SECTION	Width* (mm)	Length* (mm)
T10 25	25	180
T10 32	32	220
T10 50	50	220
T10 75	75	240
T10 100	100	320
T20 32	32	260
T20 50	50	320
T20 75	75	340
AT10 25	25	180
AT10 32	32	220
AT10 50	50	220
AT10 75	75	240
AT10 100	100	320
AT20 32	32	260
AT20 50	50	320
AT20 75	75	340
MTD8 20	20	128
MTD8 30	30	176
MTD8 50	50	176
MTD8 85	85	192
MTD8 100	100	256
RPP8 20	20	128
RPP8 30	30	176
RPP8 50	50	176
RPP8 85	85	192
RPP8 100	100	256
TG10 50	50	220
ATG10 50	50	220

*For different widths and/or lengths please contact us

SPECIAL MODIFICATIONS

Megadyne can make special extrusions on customer request to enhance specific belt properties and to better suit special applications.

Process enhancements, skilled personnel, a can-do attitude and ongoing capital equipment investments enable Megadyne to stay at the forefront of new design developments and solution delivery to customers across the spectrum of industries we serve. Let a Megadyne Technical Sales and Application Engineer create the right belt to deliver optimum performance for your application.

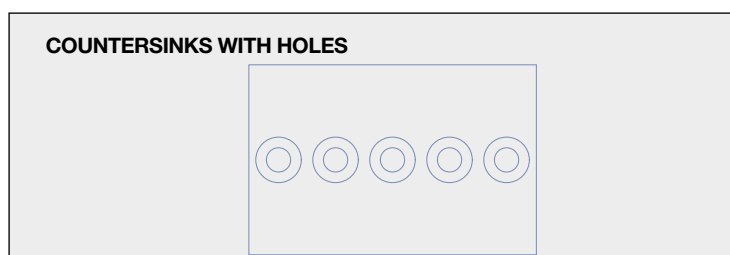
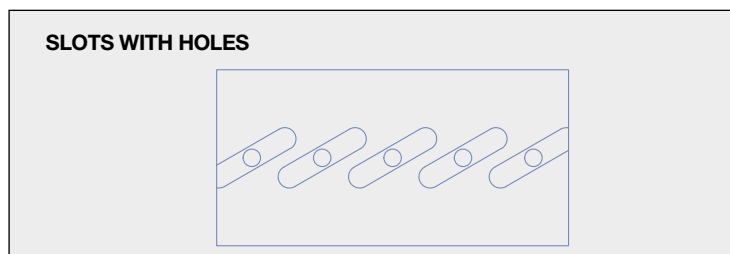
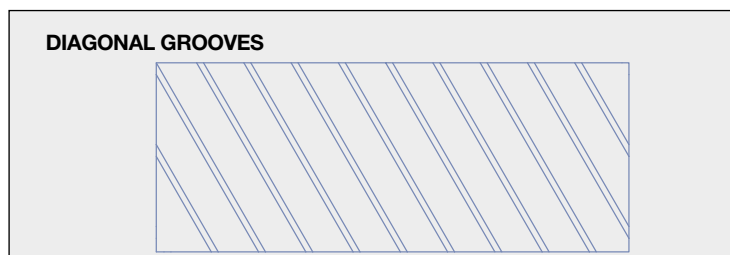
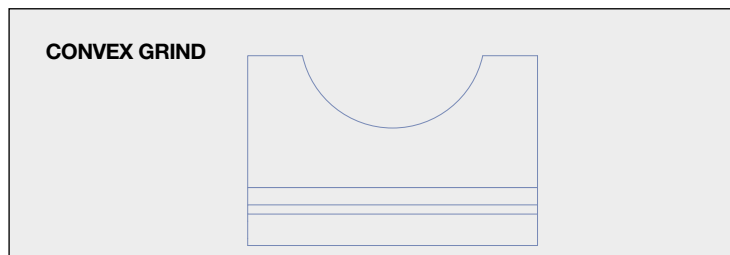
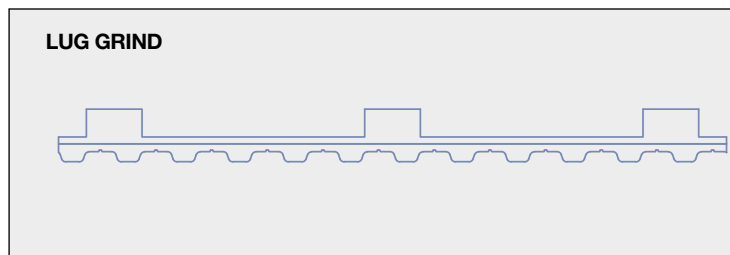
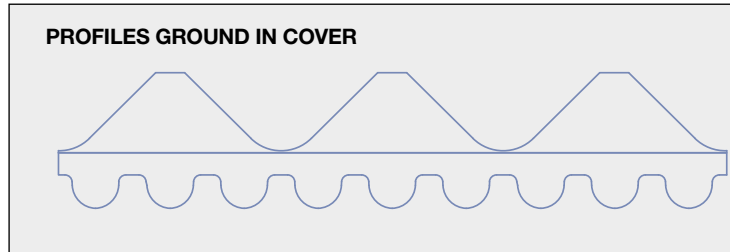

PROFILES GROUND IN COVER

A belt back can be ground to achieve a precise belt thickness as an adjunct to precision drives. When belt back grinding to a tolerance is required, the total thickness, including the tooth, must be specified.

LONGITUDINAL REWORK

Longitudinal rework along the belt back is possible on covered and uncovered belts. The profile can be machined precisely for required function. The measurement is given as the depth on the belt back. Most widths and lengths are available.

HOLES IN TIMING BELTS

Holes in timing belts can be for vacuum or air film conveying or as clearance for assembly mechanisms. Stops and cams can be attached through the holes. Customized tooling may be required depending on the layout and dimensions of holes required.



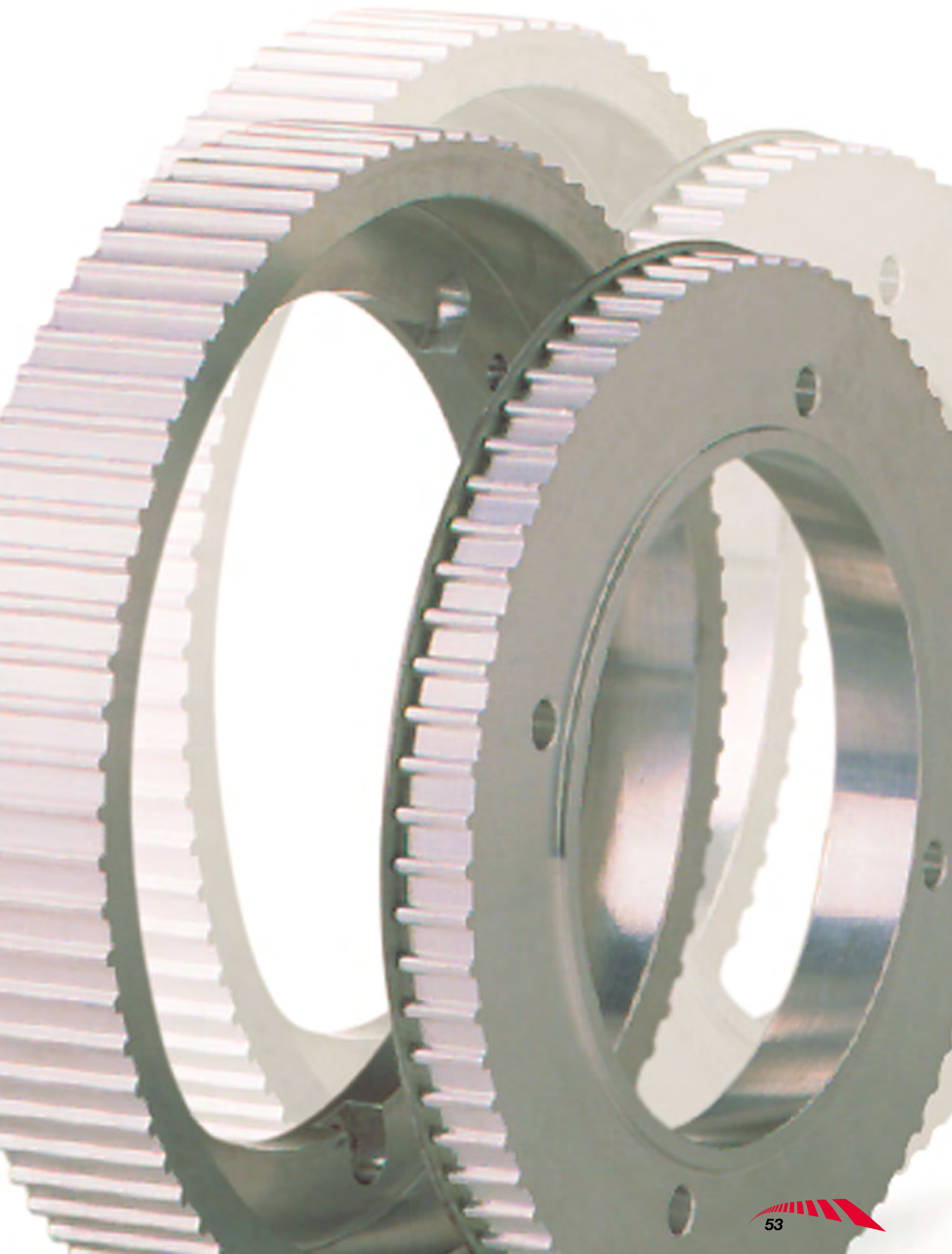

POWER TRANSMISSION COMPONENTS

Megadyne stocks and supplies an extensive range of pulleys and accessories like timing bars, taper bushes, flanges, clamping plates, toothed couplings SG, torsional flexible couplings SG and SG-HRC couplings to offer a complete drive transmission system.

Megadyne power transmission components can be designed to meet all the customer requirements.



PULLEYS

Megadyne can supply a complete drive system. A large range of standard and custom made pulleys are available: timing belts pulleys (metric pitch, HTD profile, GW), V-belt pulleys and adjustable pulleys.

For many kinds of industrial applications.

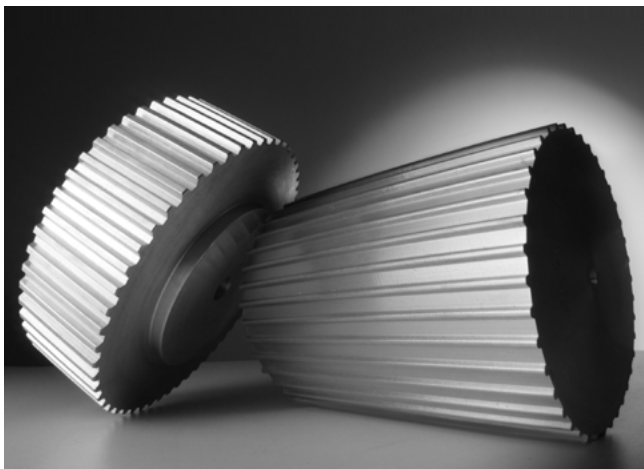

TIMING BARS

Timing bars are toothed steel or aluminium cylinders, available in standard or custom made to drawing.



FLANGES FOR PULLEYS

Flanges on request for custom-made pulleys. Custom-made, our high-quality timing pulley flanges are ideal for:

- Custom pulleys for specific applications;
- Quick and inexpensive prototypes;
- Unique material and performance specifications.

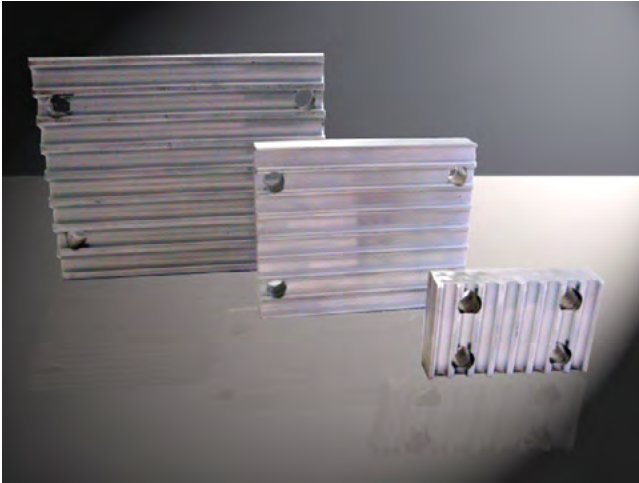

CLAMPING PLATES

Clamping Plates are used to clamp timing belt ends.

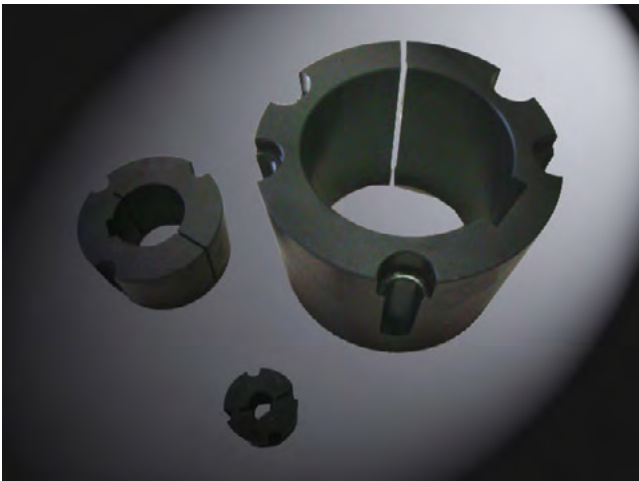

TAPER BUSHES

The taper bushes allow easy mounting and quick removal of the transmission, thus eliminating the clearance between shaft and bore. Megadyne is able to provide a range of different types of taper bushes, each with a wide range of hole diameters and different types of keyway.



MOTOR SLIDES FOR ELECTRIC MOTORS

The motor slides for electric motors allow the tension adjustment or disassembly of the belt without removing the electric motor.

POWER TRANSMISSION COMPONENTS

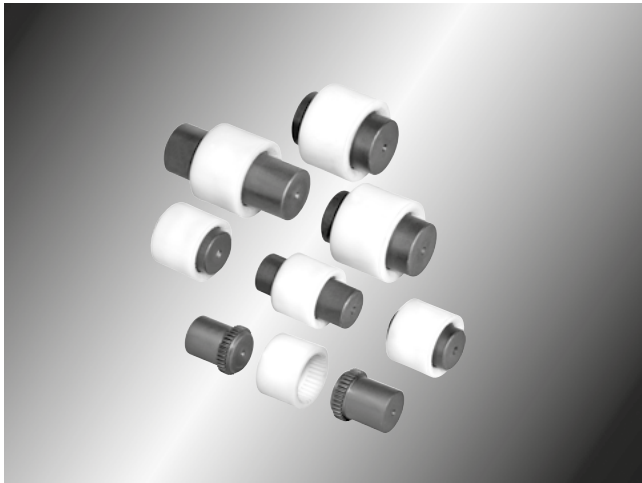

TOOTHED COUPLINGS SG

Flexible gear coupling with double curving.



TORSIONAL FLEXIBLE COUPLINGS SG

Couplings are elements connecting two rotating shafts. The design of flexible couplings is characterized by two cast iron hubs having each stubby protrusions around their perimeters pointing toward the opposite hub. The two hubs mesh loosely together, and the gaps between them are filled with blocks of elastomeric material, moulded into an asterisk-shaped element called "spider".

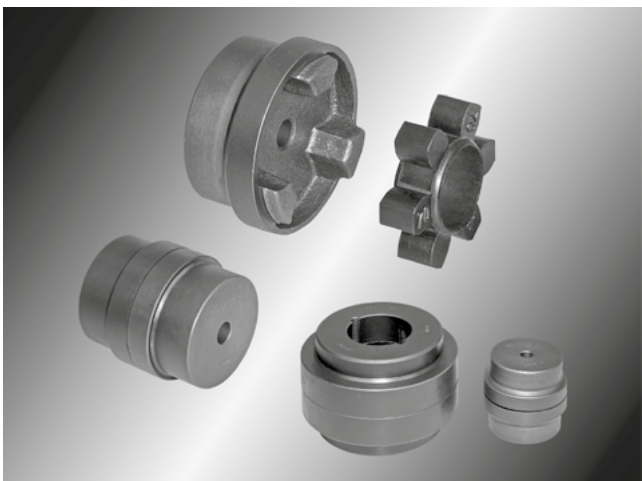

SG-HRC COUPLINGS

SG-HRC Couplings are essentially general purpose couplings with a flexible element which can accommodate higher degree of misalignment.

MEGADYNE DTM MICRO



The **MEGADYNE DTM-MICRO** is used to determine the tension of a drive belt, by measuring the frequency of the static belt. Employing the latest microprocessor technology, offers ease of use with precise measurement results. Measuring the acoustic frequency, this device can be used for all types of Power Transmission belts:

- V-Belts
- PV Belts
- Timing Belts
- Etc

The DTM-MICRO can operate regardless of pitch, colour, length, width and reinforcement type. Measuring the frequency produced by the belt, the DTM-MICRO accurately calculates and displays the reading. The frequency is directly proportional to the belt tension. The higher the frequency, the higher the belt tension is. The Kit includes:

- DTM-MICRO Tension Meter
- Sensing Head
- Connector Cable
- Carrying Case
- Instruction Manual



MEGADYNE BELTS MEASURING GAUGE

Measurement range from 500mm to 2500mm internal length (Li).

Megadyne belts measuring gauge can be easily mounted on the wall.



LITERATURE

CATALOGS AND HANDBOOK



PRODUCTS GUIDE

General informations about the full range of products



LEAFLET

Short introduction to Megadyne's products



SPECIALTY PRODUCTS GUIDE

General information about special products and reworkings.



MEGAPOWER PU TIMING BELTS

Calculation handbook for PU moulded timing belts



MEGALINEAR PU OPEN-END TIMING BELTS

Calculation handbook for PU open and joined belts

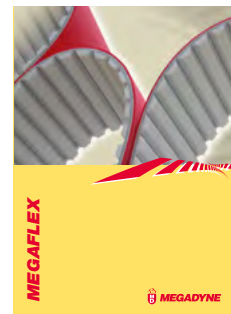

MEGAFLEX TRULY ENDLESS BELTS

Calculation handbook for PU endless timing belts



RUBBER OPEN-END

Calculation handbook for rubber open-end timing belts



ISORAN

Calculation handbook for Isoran RPP

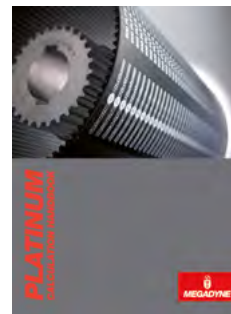

PLATINUM

Calculation handbook for Platinum belts



V-BELTS

Calculation handbook for rubber V-belts



PV-BELTS

Calculation handbook for PV-belts



MEGAFLAT

Handbook about PU and rubber Flat Belts



MEGAWELD

Handbook about PU round and V-belts



POWER TRANSMISSION COMPONENTS

Calculation handbook about power transmission components

APPLICATION LEAFLETS



AUTOMOTIVE & TIRE

Sector leaflet about automotive and tire production line



PACKAGING

Sector leaflet about Megadyne belts in packaging industry



MATERIAL HANDLING

Sector leaflet about Megadyne belts in material handling industry



MARBLE & CERAMIC

Sector leaflet about Megadyne belts in marble and ceramic industry

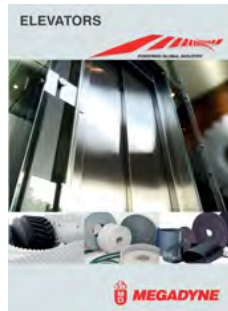

ELEVATOR

Sector leaflet about Megadyne belts in elevator industry



OIL & GAS

Sector leaflet about Megadyne belts in energy industry



WOOD

Sector leaflet about Megadyne belts wood industry



FITNESS

Sector leaflet about Megadyne belts fitness applications

PRODUCT LEAFLETS



ACCU-LINK

General information about adjustable link belt

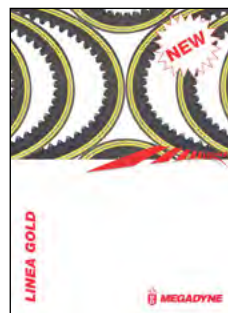

LINEA GOLD

General information about new raw edge V-belt.



OLEOSTATIC GOLD

General information about new wrapped V-belt.



PLATINUM

General information about Platinum belt.



QST SYSTEM

General information QST belts, pulleys and clamping plates.



FOOD CONTACT TIMING BELTS

General information about food contact timing belts

CONDITIONS OF SALES

MEGADYNE GENERAL CONDITIONS OF SALES

Art. 1 – Conclusion of agreements

1.1 The present General Conditions shall apply to all agreements for the sale or supply of products between Megadyne and the customer.

1.2 Megadyne shall not be bound to any terms and conditions of the customer which conflict with the present General Conditions, unless expressly agreed in writing, by fax or e-mail by Megadyne. In any case, general conditions of the customer shall not apply, unless expressly agreed in writing by Megadyne.

1.3 Offers of Megadyne shall be valid for 60 (sixty) days from the date of mailing by Megadyne, unless otherwise specified by Megadyne in the offer.

1.4 Technical specifications, performances and other elements provided in catalogues, brochures, depliants, advertising material or other documentation of Megadyne are indicative and do not bound Megadyne unless such specifications, performances or other elements are expressly provided in the agreement with the customer. Megadyne reserves the right to modify technical specifications, performances and other elements provided in the above documentation at any moment, without any obligation to replace or reimburse, totally or partially, the products purchased by the customer. Megadyne is and shall remain the owner of all rights on drawings, technical specifications and any other information communicated by Megadyne to the customer. The customer shall not disclose such information to third parties or use such information for purposes different from the definition of the order to Megadyne, unless upon prior written authorization of Megadyne.

Art. 2 - Prices

Prices are net Ex Works in Euro, and do not include packaging, transportation costs, insurance costs, custom duties, VAT or other taxes, unless otherwise agreed by Megadyne in writing, or by fax or e-mail.

Art. 3 - Payments

3.1 Payments shall be due at the domicile of Megadyne unless otherwise indicated in writing, by fax or e-mail by Megadyne.

3.2 The customer shall comply with the payment obligations also in case of claims or contestations, for whatever reason.

3.3 Breach of terms and conditions of payment shall relieve Megadyne from delivery and guarantee obligations, also with reference to deliveries other than those relating to such breach, and shall allow Megadyne to claim immediate advance payment of all sums due by the customer. Term of payment is of essence. In the event of breach of the payment obligations, Megadyne shall have the right to rescind the agreement with immediate effect and claim for damages.

3.4 In case of delay in the payment, Megadyne shall be entitled, without need to send any notice to that effect, to interests on such sum as is in arrear at a rate equal to the rate provided under the Italian law on legal interests on commercial transactions, Legislative Decrees no. 231/2002 and no. 192/2012 (or as successively amended or replaced).

Art. 4 - Reservation of title

The products sold by Megadyne shall remain the property of Megadyne until the complete payment of the price by the customer.

Art. 5 - Delivery

5.1 All references to delivery or commercial terms (Ex Works, FOB, CIF and others) in the agreement with the customer are intended as a reference to "INCOTERMS" of the International Chamber of Commerce, ed. 2010.

5.2 It is in any case understood that, independently from the delivery or commercial term agreed between Megadyne and the customer, the transport of the products is always at the risk of the customer. Any import license or authorization required in the country of destination of the products shall be for the account of the customer.

5.3 Delivery terms agreed between the parties shall be indicative for Megadyne. Partial shipments and shipment before the agreed date of delivery are allowed to Megadyne.

5.4 Any liability of Megadyne for damages arising out from delayed or lack of delivery, total or partial, is excluded to the maximum extent permitted by the applicable law.

Art. 6 - Warranty

6.1 The term "lack of conformity" (and the term "non-conforming") as used in the present General Conditions shall refer to lack of quality, non-conformity with the agreed description of the products, defects and to any other kind of lack of conformity. Products with reasonable tolerances or tolerances which conform to usages or common practices shall not be deemed as non-conforming.

6.2 Megadyne guarantees that the product sold or supplied to the customer is suitable for the ordinary use to which products of the same kind are destined. No special or particular use is guaranteed by Megadyne, unless otherwise agreed in writing by Megadyne. In any case, the products are never suitable for use in connection with aircrafts, helicopters and any air locomotion apparatus. Special or particular products must be agreed by Megadyne in writing on a case by case basis.

6.3 The customer shall examine the products promptly upon receipt. The customer shall give notice to Megadyne of any lack of conformity of the product in writing by detailing such lack of conformity not later than 15 (fifteen) days from the date when the lack of conformity was discovered or ought to have discovered, and in any case not later than 1 (one) year from the date of delivery of the product. In addition, no action, defense or counterclaim can be taken by the customer for lack of conformity of the products after 1 (one) year from the date of delivery of the products. In the event of failure to comply with the above terms and conditions, the customer loses the right to rely on any remedies for lack of conformity of the products, except in the event that the lack of conformity is due to facts of which Megadyne knew or could not be unaware at the time of conclusion of the agreement and did not disclose to the customer, except if the customer at that time knew or ought to be unaware of such facts.

6.4 Upon receipt of customer's written notice, made in compliance with the present article 6, if the product is confirmed as non-conforming, Megadyne shall at his choice:

a) repair free of charge the product, or

b) supply free of charge the customer with a new product to replace the non-conforming one, or

c) reimburse the invoiced price paid by the customer for the product proved to be non-conforming.

6.5 The guarantee is excluded in the event of defects or other lack of conformity due to failure to comply with the sizing recommended by Megadyne, non correct installation or assembly, non correct storage, use or maintenance, unauthorized repairs or modifications of the products or, in general, failure to comply with the instructions set out in the manual of use or other instructions made available by Megadyne, in the absence of the specific prior written authorization by Megadyne on a case by case basis.

6.6 The customer shall not have the right to return any product to Megadyne unless upon request by Megadyne in writing, by fax or e-mail. Costs of transport for any return requested by Megadyne shall be borne by Megadyne if the product shall be found non-conforming; otherwise such costs shall be borne by the customer, without prejudice for Megadyne's rights to claim for damages.

6.7 The warranty set forth in the present article 6 is in lieu of and replaces any liability for lack of conformity and any other contractual or legal liability arising out from, or relative to, the sale of the products. With the exception of the remedies granted to the customer according to the present article 6, no other claim or request shall be submitted by the customer. In particular, but not limited to, the customer shall have no right to claim price reduction or to rescind the agreement or any other claim. Any liability of Megadyne for damages arising out or in relation to lack of conformity is excluded to the maximum extent permitted by the applicable law.

6.8 Megadyne shall have no liability in case of earthquake, flood or any natural disasters, war, riots, strikes, shortage of materials and any circumstance of force majeure.

Art. 7 - Laws of the country of destination

Megadyne complies, in manufacturing the products, with the laws in force in the European Union. The customer shall be responsible to procure that the products (as well as their packaging, labelling, instructions, warnings, advertising, etc.) conform to the laws of the territory of destination. The customer shall indemnify and hold Megadyne harmless from any request relative to such liability.

Art. 8 - Jurisdiction and Applicable Law

8.1 For any and all disputes arising out from the agreement with the customer or relative thereto the Court of Torino shall have exclusive jurisdiction. Megadyne, at its discretion, shall also have the right to take action before the Court of the domicile of the customer.

8.2 Without prejudice for the provisions of the present General Conditions, the agreement with the customer, comprising the present General Conditions, shall be regulated Vienna convention on international sale of goods and, for any remaining matter which is outside the field of application of the Convention, by the Italian Laws.

The data and information contained in the present catalogue are up-to-dated to the date of the catalogue's printing. Megadyne Spa reserves the right to modify the specifications, performances and other information relating to the belts described in the present catalogue, at any time at its own discretion, without any prior notice.

For updating refer to our web site www.megadynegroup.com.

Technical specifications, performances and other information provided in the present catalogue are indicative and do not bound Megadyne unless such specifications, performances or other information are expressly agreed in the agreement with the customer.

We also recommend to read carefully the following documents in our web site www.megadynegroup.com:

- Megadyne General Conditions of Sale (comprising the warranty)
- Theoretical Belt Life
- Drive Components: Storage, Installation, Maintenance and Troubleshooting Handbook
- Belts standard use condition and temperature.

Copyright Notice: Megadyne Spa copyright. All rights reserved. Megadyne is and shall remain the owner of all rights on drawings, technical specifications and any other information contained in the present catalogue or otherwise communicated by Megadyne Spa to the customer. The customer shall not disclose such information to third parties or use such information for purposes different from the definition of the order to Megadyne Spa, unless upon prior written authorization of Megadyne.



AUSTRALIA**Victoria**

Phone +61 (03) 9763 6701
 au-ptsales@ammega.com

BRASIL**Sorocaba**

Phone +55 15 2101 7700
 Info.br@megadynegroup.com

CANADA**Edmonton**

Phone +1 780 461 4400
 Info.ca@megadynegroup.com

Montreal

Phone +1 514 695 1313
 Info.ca@megadynegroup.com

Toronto

Phone +1 905 602 4400
 Info.ca@megadynegroup.com

CHINA**Foshan**

Phone +86 757 8381 5530
 info.cn@megadynegroup.com

Ningbo*

Phone +86 574 8650 5008
 info.cn@megadynegroup.com

Phone +86 574 8833 4378
 sales@challengept.com

Qingdao*

Phone +86 532 8658 0951
 info.cn@megadynegroup.com

Shanghai

Phone +86 21 5447 1473
 info.cn@megadynegroup.com

COLOMBIA**Bogotá**

Phone + 57 1 390 4325
 Info.co@megadynegroup.com

Cartagena

Phone + 57 5 693 2591
 Info.co@megadynegroup.com

Mosquera – Cundinamarca

Phone +57 1 893 9890
 info.co@megadynegroup.com

CZECH REPUBLIC**Prague**

Phone +420 603 461 892
 Info.cz@megadynegroup.com

FRANCE**Paris**

Phone +33 1 6079 8200
 info.fr@megadynegroup.com

GERMANY**Borchen**

Phone +49 5251 8735 0
 info.de@megadynegroup.com

HUNGARY**Budapest**

Phone +36 23 428 628
 info.hu@megadynegroup.com

INDIA**Chennai***

Phone +91 98841 81175
 info.in@megadynegroup.com

IRELAND**Dublin**

Phone +353 1 456 6311
 ireland@challengept.com

ISRAEL**Caesarea**

Phone +972 4 637 1485
 info.il@megadynegroup.com

ITALY**Turin***

Phone +39 011 926 8052
 info@megadynegroup.com

Pescara*

Phone +39 085 9700547
 info.it@megadynegroup.com

Venice

Phone +39 041 929 367
 info.it@megadynegroup.com

JAPAN**Nagoya**

Phone +81 52 433 7400
 info.jp@megadynegroup.com

MEXICO**Mexico C.P.**

Phone +52 55 5587 3680
 info.mx@megadynegroup.com

PERU**Lima**

Phone + 51 1 713 0069
 info.pe@megadynegroup.com

POLAND**Bielsko Biala**

Phone + 48 32 447 7179
 info.pl@megadynegroup.com

Bydgoszcz*

info.pl@megadynegroup.com

SINGAPORE**Singapore**

Phone +65 62739767
 Info.sg@megadynegroup.com

SOUTH AFRICA**Johannesburg**

Phone + 27 (0) 12 661 1652
 info.za@megadynegroup.com

Phone + 27 (0) 11 3976115
 sasales@challengept.com

Cape Town

Phone +27 (0)21 9820772
 info.za@megadynegroup.com

SOUTH KOREA**Gyeonggi-do**

Phone +82 314483613-7
 Info.kr@megadynegroup.com

SPAIN**Vilanova***

Phone +34 93 811 5450
 info.es@megadynegroup.com

SWEDEN**Kristianstad**

Phone +46 10 1309600
 info.se@megadynegroup.com

THAILAND**Bangkok**

Phone +66 2 902260413
 info.th@megadynegroup.com

TURKEY**Izmir**

Phone +90 232 877 07 00
 info.tr@megadynegroup.com

U.K.**Birmingham**

Phone +44 1384 215 021
 info.uk@megadynegroup.com

Wolverhampton

Phone +44 (0) 1902 866116
 uksales@challengept.com

U.S.A**California**

Phone +1 323 265 8061
 info.us@megadynegroup.com

Florida

Phone +1 813 241 4111
 info.us@megadynegroup.com

Georgia*

info.us@megadynegroup.com

Illinois

Phone +1 630 752 0600
 info.us@megadynegroup.com

New Jersey Americas HQ

Phone +1 973 227 4904
 info.us@megadynegroup.com

North Carolina*

info.us@megadynegroup.com

Oregon

Phone +1 503 231 7224
 info.us@megadynegroup.com

Texas

Phone +1 972 438 6992
 info.us@megadynegroup.com

*** Manufacturing locations****GENERAL CONTACT INFORMATION****MEGADYNE**

Via S. Lucia, 114
 10075 Mathi (Torino)

Phone +39 011 926 8052
 info@megadynegroup.com

ammega.com

